

Panel mounted receptacle

Part number: 208A



MENNEKES
Elektrotechnik GmbH & Co. KG

Aloys-Mennekes-Straße 1
57399 Kirchhundem
GERMANY

www.MENNEKES.org

Product Description

- frame terminals
- X-CONTACT
- 20° inclination
- rubberised bayonet ring

Technical Details

Panel mounted receptacle	208A
Ampere	63A
Number of poles	5p
Clock position	9h
Nominal voltage AC	230V
Nominal frequency	50 - 60 Hz
Protection type IP	IP67
Contact carrier	standard
X-CONTACT	yes
Connection	frame terminals
Contact screw drive	PZ2, slot
Pilot contact	without pilot contact
Pilot contact switch	no
Flange dimensions	110 x 106 mm
Hole spacings	85 x 77 mm
Insertion direction	angled
Inclination	20°
Highly resistant to chemicals	no
Military version	no
Tightening torque connection terminal	2 Nm
Conductor cross-section min.	6 mm ²
Conductor cross-section max.	25 mm ²
Weight (net)	668 g
Packaging unit	5 pcs
Quantity per pallet	330 pcs

Panel mounted receptacle	208A
EAN / identification number	4015394000884

Permissible ambient conditions		
	Min.	Max.
Permissible ambient temperature	-25 °C	40 °C
Average temperature over 24 hours		35 °C

Material properties	
Housing	PC light grey [similar RAL 7035]
Hinged lid	PBT/PC blue [similar RAL 5007]
	TPE black [similar RAL 9005]
	PBT/PC squirrel grey [similar RAL 7000]
	TPE anthracite [similar RAL 7016]

Material resistance

The material resistance overview can be found on the website in the section “Knowledge” - “Product knowledge” - “Materials”.

Material and environmental properties	
RoHS 2011/65/EU incl. 2015/863/EU	✓
POP regulation (EU) 2019/1021	✓
Halogen-free	no

Regulations and Standards	
Norm	DIN EN IEC 60309-2
Declaration of Conformity	CE
Test label	EAC, CQC

Dimensional Drawing

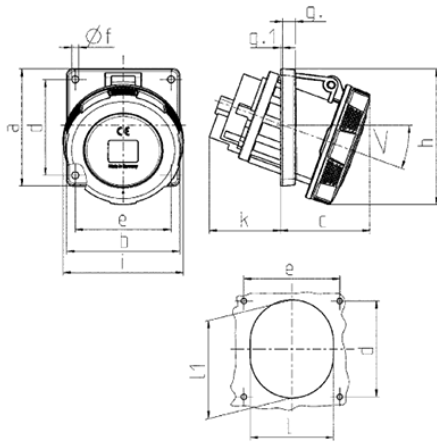

1 MB 298 1 MB 601 Dim. in mm	Amp. Poles	63			125		
		3	4	5	3	4	5
a		110	110	110	114	114	114
b		106	106	106	110	110	110
c		85	85	85	75	75	75
d		85	85	85	90	90	90
e		77	77	77	90	90	90
f		6.2	6.2	6.2	6.2	6.2	6.2
g		12	12	12	13	13	13
g.1		2	2	2	2	2	2
h		128	128	128	133	133	133
i		113	113	113	126	126	126
k		67	67	67	103	103	103
l		92	92	92	94	94	94
l1		98	98	98	107	107	107
<		20°	20°	20°	15°	15°	15°
Terminal for cond. cross section (mm ²) min.-max.		6 -25	6 -25	6 -25	25 70	25 70	25 70