

RE17RMMW

multifunction relay, Harmony Timer Relays, 8A, 1CO, 0.1s..10h, power on delay, 12...240V AC DC



Galvenā

Produkta sērija	Harmony Timer Relays
Produkta vai sastāvdaļas veids	Multifunction relay
Discrete output type	Relay
Platums	17,5 mm
Ierīces īsais nosaukums	RE17R
Time delay type	Power on-delay On-delay and off-delay Interval Off-delay Symmetrical flashing
Laika aiztures diapazons	1...10 h 0.1...1 s 6...60 s 10...100 h 6...60 min 1...10 s 1...10 min
Nominal output current	8 A

Papildinošs

Kontaktligzdas tips	1 C/O
Kontaktligzdas materiāls	Cadmium free
Augstums	90 mm
Dzīlums	72 mm
Control type	Selector switch front panel
[Us] nominālais barošanas spriegums	12...240 V AC/DC 50/60 Hz
Voltage range	0.85...1.1 Us
Supply frequency	50...60 Hz +/- 5 %
Release of input voltage	5 V
Connections - terminals	Skrūvju spaiļes, 1 x 0.5...1 x 3.3 mm ² AWG 20...AWG 12) ciets without cable end Skrūvju spaiļes, 2 x 0.5...2 x 2.5 mm ² AWG 20...AWG 14) ciets without cable end Skrūvju spaiļes, 1 x 0.2...1 x 2.5 mm ² AWG 24...AWG 14) elastīgs with cable end Skrūvju spaiļes, 2 x 0.2...2 x 1.5 mm ² AWG 24...AWG 16) elastīgs with cable end
Tightening torque	0,6...1 N.m IEC 60947-1
Korpasa materiāls	Self-extinguishing
Repeat accuracy	+/- 0.5 % IEC 61812-1
Temperature drift	+/- 0.05 %/°C
Voltage drift	+/- 0.2 %/V
Setting accuracy of time delay	+/- 10 % of full scale 25 °C IEC 61812-1
Control signal pulse width	100 ms with load in parallel typical 30 ms typical
Insulation resistance	100 MOhm 500 V DC IEC 60664-1
Reset time	120 ms on de-energisation typical
On-load factor	100 %
Power consumption in VA	0...3 VA 240 V AC
Maximum power consumption in W	1,5 W 240 V DC
Minimum switching current	10 mA 5 V DC
Maximum switching current	8 A AC/DC

The information provided in this documentation contains general descriptions and/or technical characteristics of the performance of the products contained herein. This documentation is not intended as a substitute for and is not to be used for determining suitability or reliability of these products for specific user applications. It is the duty of any such user or integrator to perform the appropriate and complete risk analysis, evaluation and testing of the products with respect to the relevant specific application or use thereof. Neither Schneider Electric Industries SAS nor any of its affiliates or subsidiaries shall be responsible or liable for misuse of the information contained herein.

Maximum switching voltage	250 V AC
Breaking capacity	2000 VA
Operating frequency	10 Hz
Electrical durability	100000 cikli pretestības 8 A 250 V AC
Mehāniskā izturība	10000000 cikli
Dielectric strength	2,5 kV 1 mA/1 minute 50 Hz IEC 61812-1
[Uimp] rated impulse withstand voltage	5 kV 1.2/50 μs
Power on delay	100 ms
Marķējums	CE
Creepage distance	4 kV/3 IEC 60664-1
Safety reliability data	MTTFd = 296.8 years B10d = 270000
Mounting position	Any position in relation to normal vertical mounting plane
Montāžas stiprinājums	35 mm DIN sliede atbilst IEC 60715
Local signalling	LED indicator on steady: relay energised, no timing in progress LED indicator 80 % ON and 20 % OFF flashing: timing in progress LED indicator 5 % ON and 95 % OFF pulsing: relay de-energised, no timing in progress (except function Di-D, Li-L)
Neto svars	0,07 kg
Time delay type	A, Ac, At, B, Bw, C, D, Di, H, Ht
Functionality	Multifunction
Compatibility code	RE17

Vide

Immunity to microbreaks	20 ms
Standarti	2006/95/EK IEC 61000-6-3 IEC 61812-1 IEC 61000-6-2 IEC 61000-6-1 2004/108/EK IEC 61000-6-4
Produkta sertifikācija	CSA[RETURN]GL[RETURN]cULus
Apkārtējā gaisa temperatūra uzglabāšanai	-30...60 °C
Apkārtējā gaisa temperatūra darbībai	-20...60 °C
IP degree of protection	IP20 IEC 60529 terminal block) IP40 IEC 60529 housing) IP50 IEC 60529 front panel)
Vibration resistance	20 m/s ² 10...150 Hz)IEC 60068-2-6
Shock resistance	15 gn 11 ms IEC 60068-2-27
Relative humidity	93 % without condensation IEC 60068-2-30
Electromagnetic compatibility	Electrostatic discharge immunity test 6 kV in contact) level 3 IEC 61000-4-2 Electrostatic discharge immunity test 8 kV in air) level 3 IEC 61000-4-2 Susceptibility to electromagnetic fields 10 V/m 80 MHz to 1 GHz) level 3 IEC 61000-4-3 Electrical fast transient/burst immunity test 1 kV capacitive connecting clip) level 3 IEC 61000-4-4 Electrical fast transient/burst immunity test 2 kV direct) level 3 IEC 61000-4-4 1.2/50 μs shock waves immunity test 1 kV differential mode) level 3 IEC 61000-4-5 1.2/50 μs shock waves immunity test 2 kV common mode) level 3 IEC 61000-4-5 Conducted RF disturbances 10 V 0.15...80 MHz) level 3 IEC 61000-4-6 Voltage dips and interruptions immunity test 0 % 1 cycle) IEC 61000-4-11 Voltage dips and interruptions immunity test 70 % 25/30 cycles) IEC 61000-4-11 Conducted and radiated emissionsclass B EN 55022

Iepakojšanas vienības

Pirmā iepakojuma vienības tips	PCE
Vienību skaits 1. iepakojumā	1
1. iepakojuma augstums	2,700 cm
1. iepakojuma platums	8,000 cm
1. iepakojuma garums	9,500 cm
1. iepakojuma svars	80,000 g

Otrā iepakojuma vienības tips	S02
Vienību skaits 2. iepakojumā	40
2. iepakojuma augstums	15,000 cm
2. iepakojuma platums	30,000 cm
2. iepakojuma garums	40,000 cm
2. iepakojuma svars	3,735 kg
Trešā iepakojuma vienības tips	P06
Vienību skaits 3. iepakojumā	640
3. iepakojuma augstums	75,000 cm
3. iepakojuma platums	60,000 cm
3. iepakojuma garums	80,000 cm
3. iepakojuma svars	70,000 kg

Piedāvājiēt ilgtspēju

Ilgspējīgs piedāvājuma statuss	Green Premium izstrādājums
REACH regula	REACH Deklarācija
ES RoHS direktīva	Proaktīva atbilstība (uz izstrādājumu neattiecas ES RoHS juridiskās saistības)
Nesatur dzīvsudrabu	Jā
Ķīnas RoHS regula	Ķīnas RoHS Deklarācija
Informācija par RoHS izņēmumiem	Jā
Vides informācijas publicēšana	Produkta Ietekme Uz Vidi
Cirkularitātes profils	Informācija Par Ekspluatācijas Izbeigšanu

Width 17.5 mm

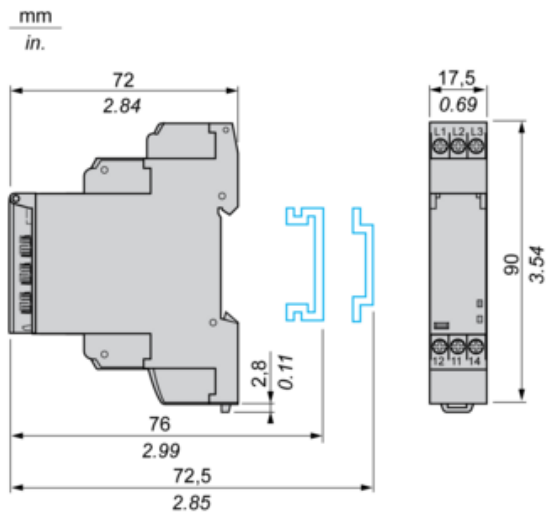

Internal Wiring Diagram

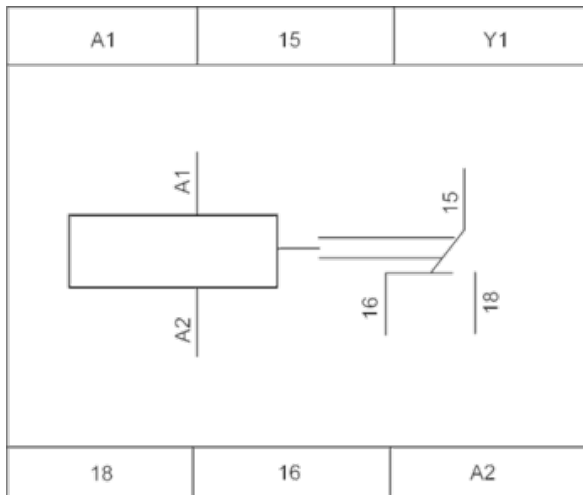

Wiring Diagram

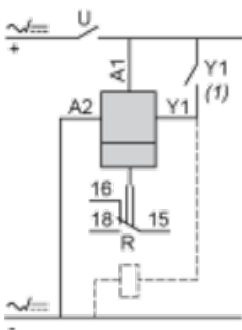

1) Contact Y1:

- Control for functions B, C, Ac, Bw, Ad, Ah, N, O, W, T, Tt.
- Partial stop for functions At, Ht and Pt.
- Function D if Di selected.
- Not used for functions A, H and P.

Function A : Power on Delay Relay

Description

The timing period T begins on energisation. After timing, the output(s) R close(s). The second output can be either timed or instantaneous.

Function: 1 Output

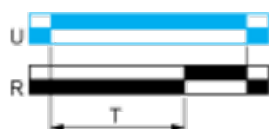

Function: 2 Outputs

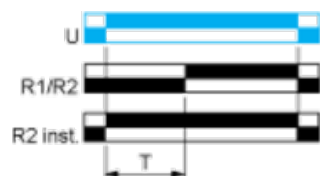

2 timed outputs (R1/R2) or 1 timed output (R1) and 1 instantaneous output (R2 inst.)

Function Ac: On-Delay & Off-Delay with Control Signal

Description

After energisation of power supply and energization of Y1 causes the timing period T to start.

At the end of this timing period, the output(s) R close(s).

When deenergization of Y1, the timing T starts.

At the end of this timing period T, the output(s) R revert(s) to its/their initial position.

The second output (R2) can be either timed (when set to "TIMED") or instantaneous (when set to "INST").

Function: 1 Output

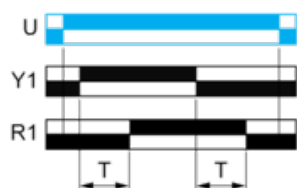

Function: 2 Outputs

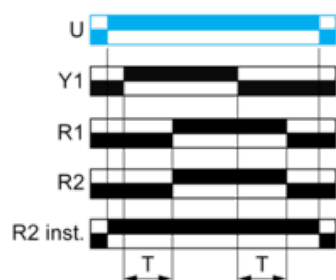

Function At : Power on Delay Relay (Summation) with Control Signal

Description

After power-up, the first opening of control contact C starts the timing. Timing can be interrupted each time control contact closes. When the cumulative total of time periods elapsed reaches the pre-set value T, the output relay closes.

Function: 1 Output

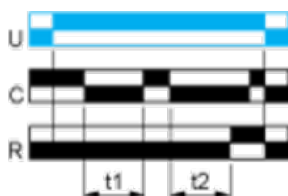

$$T = t1 + t2 + \dots$$

Function B : Interval Relay with Control Signal

Description

After power-up, pulsing or maintaining control contact C starts the timing T. The output R closes for the duration of the timing period T then reverts to its initial state.

Function: 1 Output

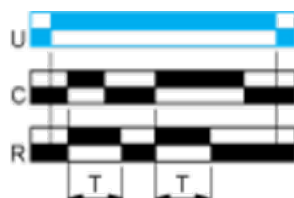

Function Bw : Double Interval Relay with Control Signal

Description

On closing and opening of control contact C, the output R closes for the duration of the timing period T.

Function: 1 Output



Function C : Off-Delay Relay with Control Signal

Description

After power-up and closing of the control contact C, the output R closes. When control contact C re-opens, timing T starts. At the end of the timing period, the output(s) R revert(s) to its/their initial state. The second output can be either timed or instantaneous.

Function: 1 Output

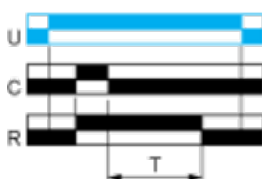

Function: 2 Outputs

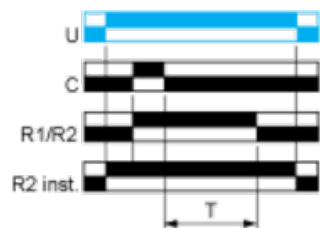

2 timed outputs (R1/R2) or 1 timed output (R1) and 1 instantaneous output (R2 inst.)

Function D: Symmetrical Flashing Relay (Starting Pulse Off)

Description

On energisation of power supply, output(s) R starts at its/their initial state for timing duration T then change(s) to output(s) R close(s) for the same timing duration T. This cycle is repeated indefinitely until power supply removal. Specially for RE17*, RE22R2AMU, RE22R2MMW, RE22R2MMU, RE22R2MJU, this D function can only be initiated by energizing Y1 permanently. The second output (R2) can be either timed (when set to "TIMED") or instantaneous (when set to "INST").

Function: 1 Output

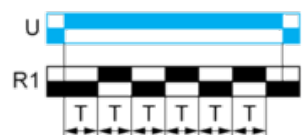

Function: 2 Outputs

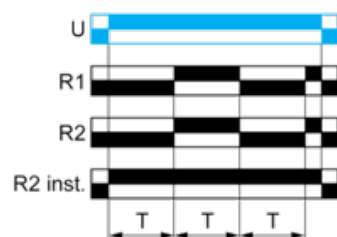

Function: 1 Output with Retrigger / Restart Control

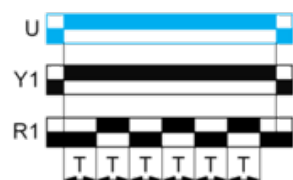

Function: 2 Output with Retrigger / Restart Control

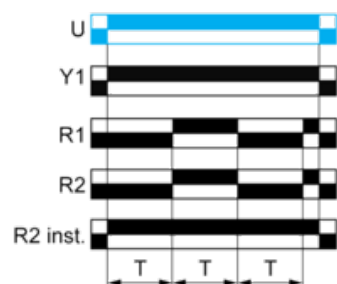

Function Di : Symmetrical Flasher Relay (Starting Pulse On)

Description

Repetitive cycle with two timing periods T of equal duration, with output(s) R changing state at the end of each timing period T. The second output can be either timed or instantaneous.

Function: 1 Output



Function: 2 Outputs

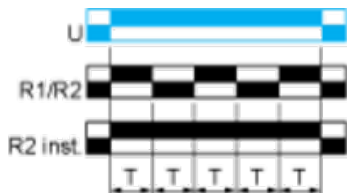

2 timed outputs (R1/R2) or 1 timed output (R1) and 1 instantaneous output (R2 inst.)

Function H : Interval Relay

Description

On energisation of the relay, timing period T starts and the output(s) R close(s). At the end of the timing period T, the output(s) R revert(s) to its/their initial state. The second output can be either timed or instantaneous.

Function: 1 Output



Function: 2 Outputs

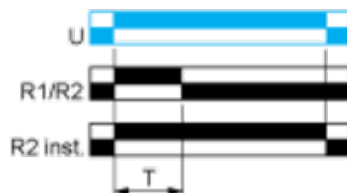

2 timed outputs (R1/R2) or 1 timed output (R1) and 1 instantaneous output (R2 inst.)

Function Ht: Interval Relay & With Pause / Summation Control

Description

On energisation of power supply, output(s) R close(s) and timing period T starts.

The timing can be interrupted / paused each time X1 energizes.

When the cumulative total of time periods elapsed reaches the pre-set value T, the output(s) R revert(s) to its/their initial state. Reenergization of X1 will also cause output(s) R close(s) if the time has elapsed and restart the same operation as described at the beginning.

Except for RE17*, RE22R2MMW, RENF22R2MMW, RE22R2MMU and RE22R2MJU, timing can be interrupted / paused each time Y1 energizes.

The second output (R2) can be either timed (when set to "TIMED" or instantaneous (when set to "INST").

Function: 1 Output

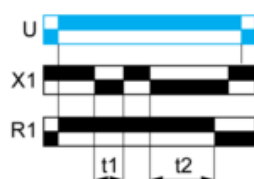

$T = t1 + t2 + \dots$

Function: 2 Outputs

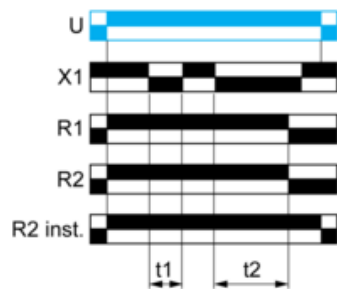

$T = t_1 + t_2 + \dots$

Function: 1 Output with Retrigger / Restart Control

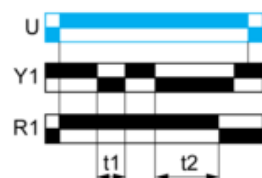

$T = t_1 + t_2 + \dots$

Function: 2 Outputs with Retrigger / Restart Control

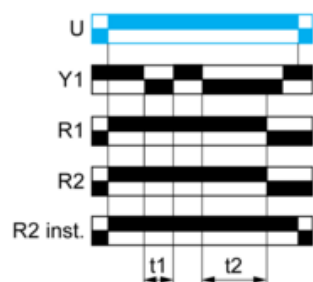

$T = t_1 + t_2 + \dots$

Legend

Relay de-energised

Relay energised

Output open

Output closed

C	Control contact
G	Gate
R	Relay or solid state output
R1/R2	2 timed outputs
R2 inst.	The second output is instantaneous if the right position is selected
T	Timing period
Ta -	Adjustable On-delay
Tr -	Adjustable Off-delay
U	Supply