



Galvenā

Produkta sērija	Modicon M221
Produkta vai sastāvdaļas veids	Logic controller
[Us] rated supply voltage	24 V DC
Discrete input number	24, discrete input 4 fast input IEC 61131-2 Type 1
Analogue input number	2 0...10 V
Discrete output type	Transistor
Discrete output number	16 transistor 2 fast output
Discrete output voltage	24 V DC
Discrete output current	0.5 A

Papildinošs

Discrete I/O number	40
Maximum number of I/O expansion module	7 local 14 remote
Supply voltage limits	20,4...28,8 V
Momentānā strāva leslēgšanas brīdī	35 A
Maximum power consumption in W	17 W 24 V with max number of I/O expansion module) 4,9 W 24 V without I/O expansion module)
Power supply output current	0,52 A 5 V expansion bus 0,3 A 24 V expansion bus
Discrete input logic	Sink or source (positive/negative)
Discrete input voltage	24 V
Discrete input voltage type	DC
Analogue input resolution	10 bits
LSB value	10 mV
Conversion time	1 ms per channel + 1 controller cycle time analog input
Permitted overload on inputs	+/- 30 V DC 5 min maksimums)analog input +/- 13 V DC permanent)analog input
Voltage state 1 guaranteed	>= 15 V ievade
Voltage state 0 guaranteed	<= 5 V ievade
Discrete input current	7 MA discrete input 5 mA fast input
Input impedance	3.4 kOhm discrete input 100 kOhm analog input 4.9 kOhm fast input
Response time	35 µs turn-off, I2...I5 ievade 5 µs turn-on, I0, I1, I6, I7 fast input 35 µs turn-on, other terminals ievade 5 µs turn-off, I0, I1, I6, I7 fast input 100 µs turn-off, other terminals ievade 5 µs turn-on, turn-off, Q0...Q1 izvade 50 µs turn-on, turn-off, Q2...Q3 izvade 300 µs turn-on, turn-off, other terminals izvade
Configurable filtering time	0 ms ievade 3 ms ievade 12 ms ievade
Discrete output logic	Positive logic (source)
Maximum current per output common	4 A

The information provided in this documentation contains general descriptions and/or technical characteristics of the performance of the products contained herein. This documentation is not intended as a substitute for and is not to be used for determining suitability or reliability of these products for specific user applications. It is the duty of any such user or integrator to perform the appropriate and complete risk analysis, evaluation and testing of the products with respect to the relevant specific application or use thereof. Neither Schneider Electric Industries SAS nor any of its affiliates or subsidiaries shall be responsible or liable for misuse of the information contained herein.

Izejas frekvence	100 KHz fast output (PWM/PLS mode) Q0...Q1 5 KHz izvade Q2...Q3 0,1 kHz izvade Q4...Q15
Absolute accuracy error	+/- 1 % of full scale analog input
Maximum leakage current	0,1 mA transistor output
Maximum voltage drop	<1 V
Mechanical durability	20000000 cikli transistor output
Maximum tungsten load	<12 W output and fast output
Protection type	Pārslodzes un īssavienojuma aizsardzība 1 A
Reset time	1 s automatic reset
Memory capacity	256 kB user application and data RAM 10000 instructions 256 kB internal variables RAM
Data backed up	256 kB built-in flash memory backup of application and data
Data storage equipment	2 GB SD karte nav obligāti)
Battery type	BR2032 or CR2032X lithium non-rechargeable
Backup time	1 year 25 °C by interruption of power supply)
Execution time for 1 KInstruction	0,3 ms event and periodic task
Execution time per instruction	0.2 μs Boolean
Exct time for event task	60 μs response time
Maximum size of object areas	512 %KW constant words 255 %TM timers 255 %C counters 8000 %MW memory words 512 %M memory bits
Realtime clock	With
Clock drift	<= 30 s/month 25 °C
Regulation loop	Adjustable PID regulator up to 14 simultaneous loops
Positioning functions	PTO 2 pulse/direction 100 kHz) PTO 1 CW/CCW 100 kHz)
Pieejamā funkcija	PWM PLS Frequency generator
Counting input number	4 fast input (HSC mode) 100 kHz 32 bits
Counter function	A/B Pulse/Direction Single phase
Integrated connection type	USB ports mini B USB 2.0 Non isolated serial link serial 1 RJ45 RS232/RS485 Ethernet RJ45
Supply	Serial)serial link supply 5 V, <200 mA
Transmission rate	1.2...115.2 kbit/s (115.2 kbit/s by default) 15 m RS485 1.2...115.2 kbit/s (115.2 kbit/s by default) 3 m RS232 480 Mbit/s USB
Communication port protocol	USB ports USB - SoMachine-Network Non isolated serial link Modbus master/slave - RTU/ASCII or SoMachine-Network Ethernet
Port Ethernet	10BASE-T/100BASE-TX 1 100 m copper cable
Komunikācijas pakalpojums	Modbus TCP slave device Ethernet/IP adapter Modbus TCP server Modbus TCP client DHCP client
Lokālā signalizēšana	Priekš PWR 1 LED (zaļš) Priekš RUN 1 LED (zaļš) Priekš module error (ERR) 1 LED (sarkans) Priekš SD card access (SD) 1 LED (zaļš) Priekš BAT 1 LED (sarkans) Priekš I/O state 1 LED uz kanālu (zaļš) Priekš SL 1 LED (zaļš) Priekš ACT Ethernet network activity (zaļš) Priekš Link (Link Status) Ethernet network link (dzeltens)
Electrical connection	Removable screw terminal block ieejai Removable screw terminal block izejai Terminal block, 3 for connecting the 24 V DC power supply Connector, 4 for analogue inputs Mini B USB 2.0 connector for a programming terminal

Maximum cable distance between devices	Shielded cable <10 m fast input Unshielded cable <30 m izvade Unshielded cable <30 m digital input Unshielded cable <1 m analog input Shielded cable <3 m fast output
Insulation	Between input and internal logic 500 V AC Between fast input and internal logic 500 V AC Non-insulated between inputs Between output and internal logic 500 V AC Non-insulated between analogue input and internal logic Non-insulated between analogue inputs
Marķējums	CE
Mounting support	Top hat type TH35-15 rail IEC 60715 Top hat type TH35-7.5 rail IEC 60715 Plate or panel with fixing kit
Augstums	90 mm
Dziļums	70 mm
Platums	160 mm
Neto svars	0,456 kg

Vide





Standarti	IEC 61131-2 UL 508 CAN/CSA C22.2 No. 213 IACS E10 ANSI/ISA 12-12-01
Produkta sertifikācija	RCM[RETURN]EAC[RETURN]ABS[RETURN]LR[RETURN]cULus[RETURN]DNV-GL[RETURN]CE[RETURN]UKCA[RETURN]cULus HazLoc
Vides raksturlielumi	Ordinary and hazardous location
Resistance to electrostatic discharge	8 kV in air IEC 61000-4-2 4 kV on contact IEC 61000-4-2
Resistance to electromagnetic fields	10 V/m 80 MHz...1 GHz IEC 61000-4-3 3 V/m 1.4 GHz...2 GHz IEC 61000-4-3 1 V/m 2...2.7 GHz IEC 61000-4-3
Resistance to magnetic fields	30 A/m 50/60 Hz IEC 61000-4-8
Resistance to fast transients	2 kV IEC 61000-4-4 power lines) 2 kV IEC 61000-4-4 relay output) 1 kV IEC 61000-4-4 I/O) 1 kV IEC 61000-4-4 Ethernet line) 1 kV IEC 61000-4-4 serial link)
Surge withstand	2 kV power lines (AC) common mode IEC 61000-4-5 2 kV relay output common mode IEC 61000-4-5 1 kV I/O common mode IEC 61000-4-5 1 kV shielded cable common mode IEC 61000-4-5 0,5 kV power lines (DC) differential mode IEC 61000-4-5 1 kV power lines (AC) differential mode IEC 61000-4-5 1 kV relay output differential mode IEC 61000-4-5 0,5 kV power lines (DC) common mode IEC 61000-4-5
Resistance to conducted disturbances	10 V 0.15...80 MHz IEC 61000-4-6 3 V 0.1...80 MHz Marine specification (LR, ABS, DNV, GL) 10 V spot frequency (2, 3, 4, 6.2, 8.2, 12.6, 16.5, 18.8, 22, 25 MHz) Marine specification (LR, ABS, DNV, GL)
Electromagnetic emission	Conducted emissions 79 dB μ V/m QP/66 dB μ V/m AV power lines (AC))0,15...0,5 MHz IEC 55011 Conducted emissions 73 dB μ V/m QP/60 dB μ V/m AV power lines (AC))0,5...300 MHz IEC 55011 Conducted emissions 120...69 dB μ V/m QP power lines)10...150 kHz IEC 55011 Conducted emissions 63 dB μ V/m QP power lines)1,5...30 MHz IEC 55011 Radiated emissions 40 dB μ V/m QP class A 10 m)30...230 MHz IEC 55011 Conducted emissions 79...63 dB μ V/m QP power lines)150...1500 kHz IEC 55011 Radiated emissions 47 dB μ V/m QP class A 10 m)200...1000 MHz IEC 55011
Immunity to microbreaks	10 ms
Ambient air temperature for operation	-10...55 °C horizontal installation) -10...35 °C vertical installation)
Apkārte jā gaisa temperatūra uzglabāšanai	-25...70 °C
Relative humidity	10...95 %, without condensation in operation) 10...95 %, without condensation in storage)
IP aizsardzības pakāpe	IP20 with protective cover in place
Piesārņojuma pakāpe	<= 2

Darbības augstums	0...2000 m
Uzglabāšanas augstums	0...3000 m
Vibration resistance	3.5 mm 5...8,4 Hz symmetrical rail 3.5 mm 5...8,4 Hz panel mounting 1 gn 8,4...150 Hz symmetrical rail 1 gn 8,4...150 Hz panel mounting
Shock resistance	147 m/s ² 11 ms

Iepakojšanas vienības

Pirmā iepakojuma vienības tips	PCE
Vienību skaits 1. iepakojumā	1
1. iepakojuma augstums	11,139 cm
1. iepakojuma platums	14,201 cm
1. iepakojuma garums	21,045 cm
1. iepakojuma svars	760,0 g
Otrā iepakojuma vienības tips	CAR
Vienību skaits 2. iepakojumā	12
2. iepakojuma augstums	29,3 cm
2. iepakojuma platums	39,2 cm
2. iepakojuma garums	56,9 cm
2. iepakojuma svars	10,211 kg
Trešā iepakojuma vienības tips	P12
Vienību skaits 3. iepakojumā	144
3. iepakojuma augstums	105,0 cm
3. iepakojuma platums	120,0 cm
3. iepakojuma garums	80,0 cm
3. iepakojuma svars	132 kg

Piedāvājiēt ilgtspēju

Ilgtspējīgs piedāvājuma statuss	Green Premium izstrādājums
REACH regula	 REACH Deklarācija
ES RoHS direktīva	Proaktīva atbilstība (uz izstrādājumu neattiecas ES RoHS juridiskās saistības)
Nesatur dzīvsudrabu	Jā
Ķīnas RoHS regula	 Ķīnas RoHS Deklarācija
Informācija par RoHS izņēmumiem	 Jā
Vides informācijas publiskošana	 Produkta Ietekme Uz Vidi
Cirkularitātes profils	 Informācija Par Eksploatācijas Izbeigšanu
WEEE	Eiropas Savienības tirgū no šī produkta ir jāatbrīvojas, ievērojot noteiktu atkritumu savākšanas kārtību, un produkts nedrīkst nonākt sadzīves atkritumu tvertnēs.
Nesatur PVH	Jā

Dimensions

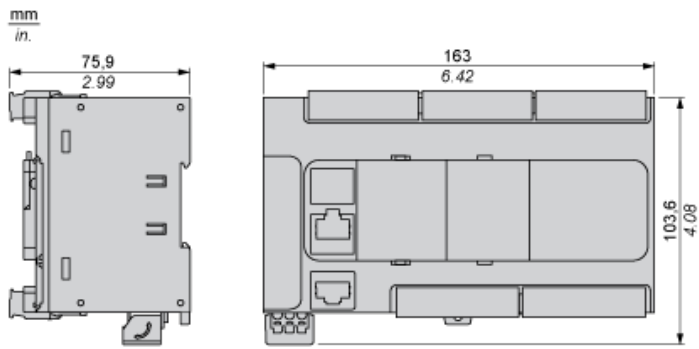

Mounting on a Rail



Direct Mounting on a Panel Surface



- (1) Install a mounting strip

Mounting Hole Layout

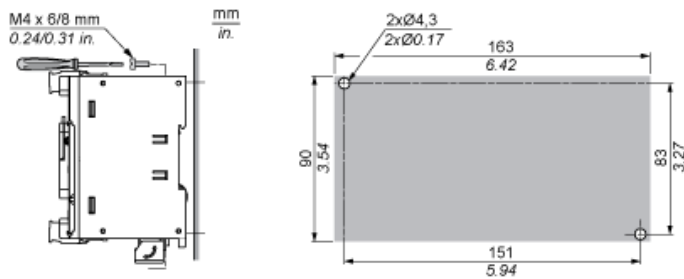

Mounting

Correct Mounting Position



Acceptable Mounting Position



Incorrect Mounting Position



Clearance



Digital Inputs

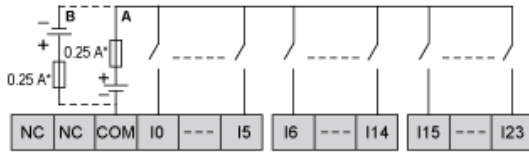

- (*) Type T fuse
- (A) Sink wiring (positive logic).
- (B) Source wiring (negative logic).

Connection of the Fast Inputs

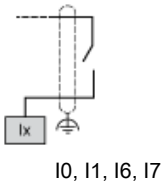

Transistor Outputs

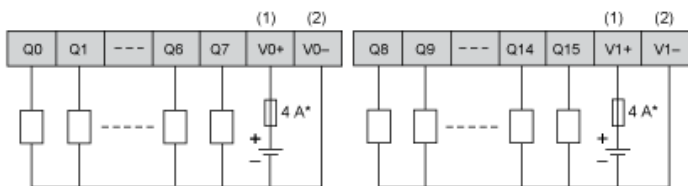

- (*) Type T fuse
- (1) The V0+ and V1+ terminals are not connected internally.
- (2) The V0- and V1- terminals are not connected internally.

Connection of the Fast Outputs

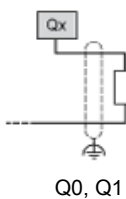

Analog Inputs

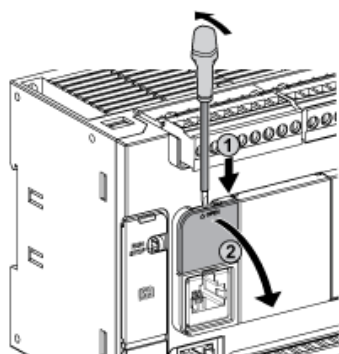

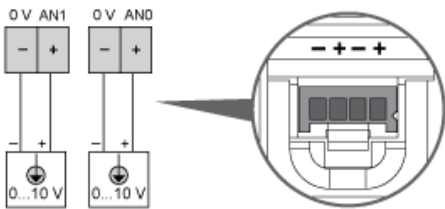

The (-) poles are connected internally.

Pin	Wire Color
0 V	Black
AN1	Red
0 V	Black
AN0	Red

Ethernet Connection

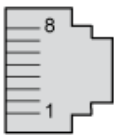

Pin N°	Signal
1	TD+
2	TD-
3	RD+
4	-
5	-
6	RD-
7	-
8	-

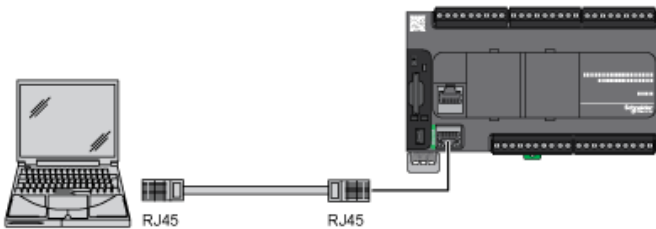

USB Mini-B Connection

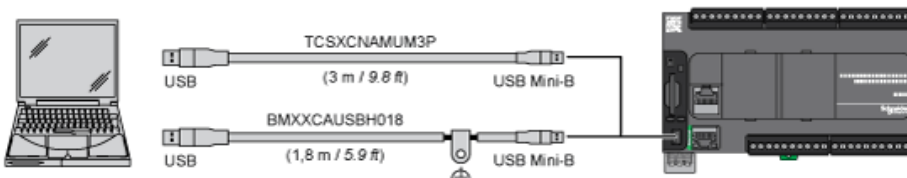

SL1 Connection

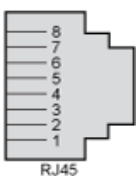

SL1

N °	RS 232	RS 485
1	RxD	N.C.
2	TxD	N.C.
3	RTS	N.C.
4	N.C.	D1
5	N.C.	D0
6	CTS	N.C.
7	N.C.*	5 Vdc
8	Common	Common

N.C.: not connected

* : 5 Vdc delivered by the controller. Do not connect.

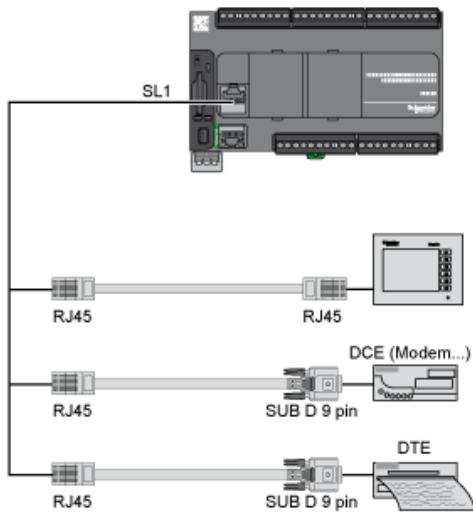

Derating Curves

Embedded Digital Inputs (No Cartridge)

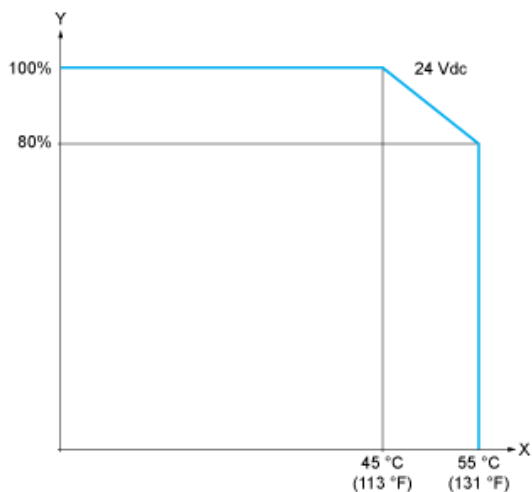

X : Ambient temperature
Y : Input simultaneous ON ratio

Embedded Digital Inputs (with Cartridge)

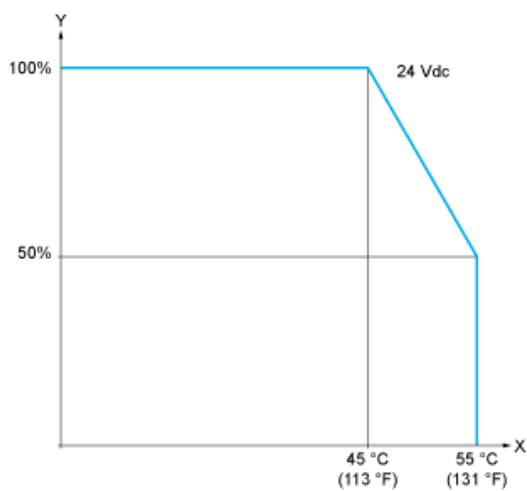

X : Ambient temperature
Y : Input simultaneous ON ratio

Derating Curves

Embedded Digital Outputs (No Cartridge)



X : Ambient temperature
Y : Output simultaneous ON ratio

Embedded Digital Outputs (with Cartridge)



X : Ambient temperature
Y : Output simultaneous ON ratio