



## Galvenā

Produkta sērija	Harmony XALF Harmony XB5
Produkta vai sastāvdaļas veids	Head for selector switch
Ierīces īsais nosaukums	ZB5
Bezel material	Dark grey plastic
Mounting diameter	22 mm
Head type	Standard
Daudzums nedalāms	1
Shape of signaling unit head	Round
Type of operator	Stay put
Operator profile	Black standard handle
Operator position information	2 positions 90°

## Papildinošs

CAD overall width	29 mm
CAD overall height	29 mm
CAD overall depth	46 mm
Neto svars	0,017 kg
Mehāniskā izturība	1000000 cikli
Station name	XALD 1...5 cut-outs XALK 2...5 cut-outs
Electrical composition code	C3 6 single front mounting C4 6 single and double front mounting C5 5 single front mounting C6 5 single and double front mounting C7 4 single front mounting C8 4 single and double front mounting C11 3 single front mounting C15 1 single front mounting SF1 3 single front mounting SR1 3 single rear mounting
Ierīces komplektācija	Pamatelements

## Vide

Aizsargparklājums	TH
Apkārtējā gaisa temperatūra uzglabāšanai	-40...70 °C
Apkārtējā gaisa temperatūra darbībai	-40...70 °C
Overvoltage category	Class II IEC 60536
IP degree of protection	IP67 IEC&nbsp;60529 IP69 IEC&nbsp;60529 IP69K
NEMA degree of protection	NEMA 13 NEMA 4X
Resistance to high pressure washer	7000000 Pa 55 °C 0.1 m
Triecienizturības klase (IK)	IK06 conforming to IEC 50102

The information provided in this documentation contains general descriptions and/or technical characteristics of the performance of the products contained herein. This documentation is not intended as a substitute for and is not to be used for determining suitability or reliability of these products for specific user applications. It is the duty of any such user or integrator to perform the appropriate and complete risk analysis, evaluation and testing of the products with respect to the relevant specific application or use thereof. Neither Schneider Electric Industries SAS nor any of its affiliates or subsidiaries shall be responsible or liable for misuse of the information contained herein.

Standarti	JIS C8201-5-1 CSA C22.2 No 14 UL 508 IEC 60947-1 IEC 60947-5-4 IEC 60947-5-1 JIS C8201-1
Produkta sertifikācija	GL[RETURN]CSA[RETURN]BV[RETURN]DNV[RETURN]LROS (Lloyds register of shipping)[RETURN]UL sarakstā
Vibration resistance	5 gn 2...500 Hz)IEC 60068-2-6
Shock resistance	30 gn 18 ms) half sine wave acceleration IEC 60068-2-27 50 gn 11 ms) half sine wave acceleration IEC 60068-2-27

### Iepakojšanas vienības

Pirmā iepakojuma vienības tips	PCE
Vienību skaits 1. iepakojumā	1
1. iepakojuma augstums	3,700 cm
1. iepakojuma platums	5,400 cm
1. iepakojuma garums	6,000 cm
1. iepakojuma svars	24,000 g
Otrā iepakojuma vienības tips	BB1
Vienību skaits 2. iepakojumā	5
2. iepakojuma augstums	5,000 cm
2. iepakojuma platums	3,400 cm
2. iepakojuma garums	26,500 cm
2. iepakojuma svars	121,000 g
Trešā iepakojuma vienības tips	S03
Vienību skaits 3. iepakojumā	200
3. iepakojuma augstums	30,000 cm
3. iepakojuma platums	30,000 cm
3. iepakojuma garums	40,000 cm
3. iepakojuma svars	5,304 kg

### Piedāvājiem ilgtspēju

Ilgtspējīgs piedāvājuma statuss	Green Premium izstrādājums
REACH regula	<a href="#">REACH Deklarācija</a>
Nesatur REACH SVHC	Jā
ES RoHS direktīva	Proaktīva atbilstība (uz izstrādājumu neattiecas ES RoHS juridiskās saistības) <a href="#">ES RoHS deklarācija</a>
Nesatur toksiskus smagos metālus	Jā
Nesatur dzīvsudrabu	Jā
Ķīnas RoHS regula	<a href="#">Ķīnas RoHS Deklarācija</a>
Informācija par RoHS izņēmumiem	<a href="#">Jā</a>
Vides informācijas publiskošana	<a href="#">Produkta Ietekme Uz Vidi</a>
Cirkularitātes profils	<a href="#">Informācija Par Eksploatācijas Izbeigšanu</a>

### Līguma garantija

Garantija	18 months
-----------	-----------

---

Dimensions

---

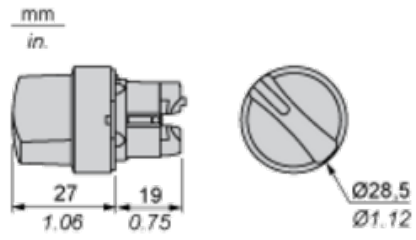

Panel Cut-out for Pushbuttons, Switches and Pilot Lights (Finished Holes, Ready for Installation)

Connection by Screw Clamp Terminals or Plug-in Connectors or on Printed Circuit Board



- (1) Diameter on finished panel or support
- (2) For selector switches and Emergency stop buttons, use of an anti-rotation plate type ZB5AZ902 is recommended.
- (3)  $\varnothing 22.5$  mm recommended ( $\varnothing 22.3_0^{+0.4}$ ) /  $\varnothing 0.89$  in. recommended ( $\varnothing 0.88$  in.  $_0^{+0.016}$ )

Connections	a in mm	a in in.	b in mm	b in in.
By screw clamp terminals or plug-in connector	40	1.57	30	1.18
By Faston connectors	45	1.77	32	1.26
On printed circuit board	30	1.18	30	1.18

Detail of Lug Recess



- (1) Diameter on finished panel or support
- (2) For selector switches and Emergency stop buttons, use of an anti-rotation plate type ZB5AZ902 is recommended.
- (3)  $\varnothing 22.5$  mm recommended ( $\varnothing 22.3_0^{+0.4}$ ) /  $\varnothing 0.89$  in. recommended ( $\varnothing 0.88$  in.  $_0^{+0.016}$ )

Pushbuttons, Switches and Pilot Lights for Printed Circuit Board Connection

### Panel Cut-outs (Viewed from Installer's Side)

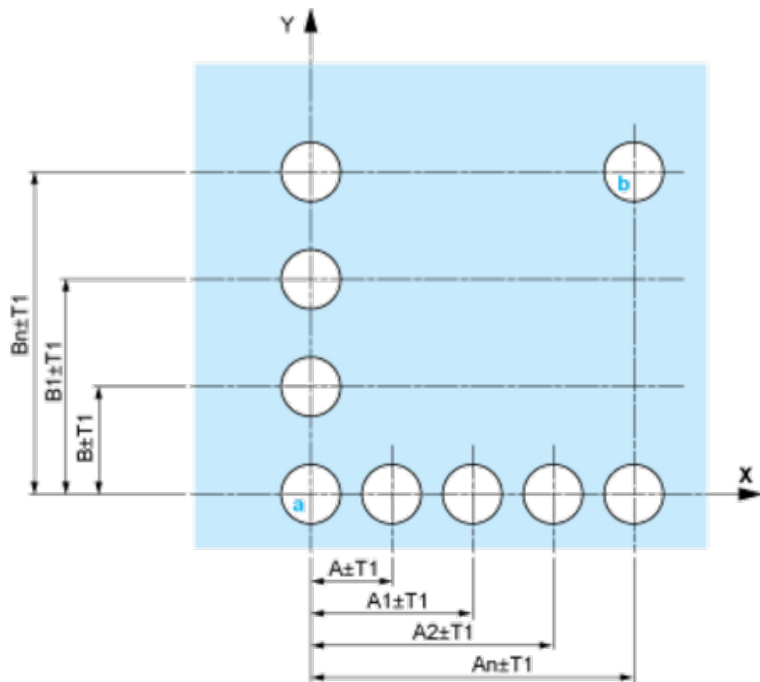

A: 30 mm min. / 1.18 in. min.

B: 40 mm min. / 1.57 in. min.

### Printed Circuit Board Cut-outs (Viewed from Electrical Block Side)

Dimensions in mm

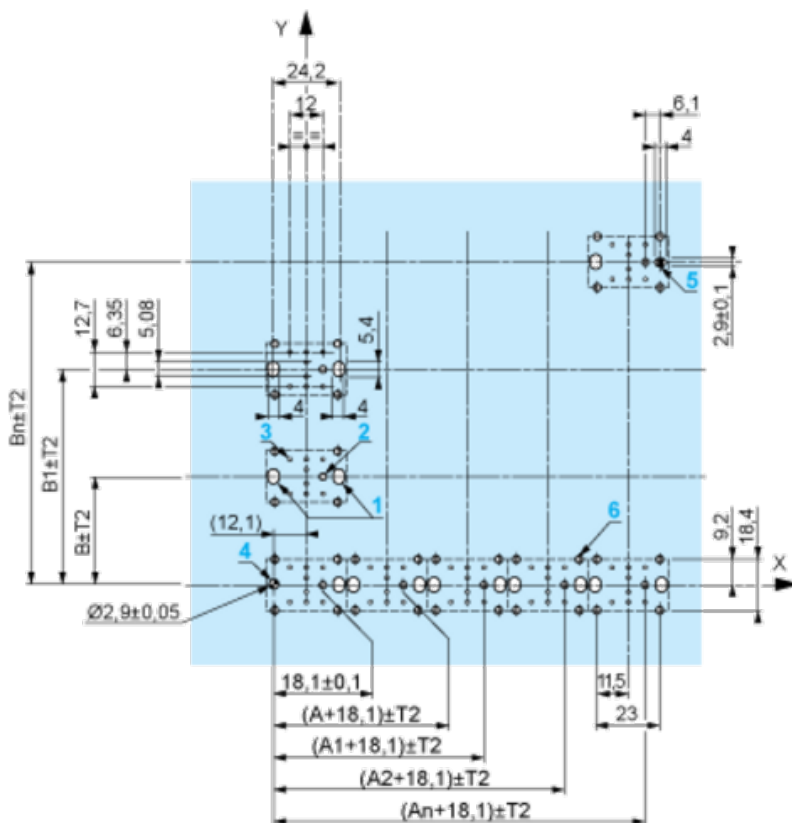

A: 30 mm min.

B: 40 mm min.

Dimensions in in.



A: 1.18 in. min.

B: 1.57 in. min.

### General Tolerances of the Panel and Printed Circuit Board

The cumulative tolerance must not exceed 0.3 mm / 0.012 in.:  $T1 + T2 = 0.3$  mm max.

### Installation Precautions

- Minimum thickness of circuit board: 1.6 mm / 0.06 in.
- Cut-out diameter: 22.4 mm ± 0.1 / 0.88 in. ± 0.004
- Orientation of body/fixing collar ZB5AZ009:  $\pm 2^\circ 30'$  (excluding cut-outs marked a and b).
- Tightening torque of screws ZBZ006: 0.6 N.m (5.3 lbf.in) max.
- Allow for one ZB5AZ079 fixing collar/pillar and its fixing screws:
  - every 90 mm / 3.54 in. horizontally (X), and 120 mm / 4.72 in. vertically (Y).
  - with each selector switch head (ZB5AD•, ZB5AJ•, ZB5AG•).

The fixing centers marked a and b are diagonally opposed and must align with those marked 4 and 5.



(1) Head ZB5AD•

(2) Panel

(2) Nut

#### (4) Printed circuit board

##### Mounting of Adapter (Socket) ZBZ01•

- 1 2 elongated holes for ZBZ006 screw access
- 2 1 hole  $\varnothing$  2.4 mm  $\pm$  0.05 / 0.09 in.  $\pm$  0.002 for centring adapter ZBZ01•
- 3 8  $\times$   $\varnothing$  1.2 mm / 0.05 in. holes
- 4 1 hole  $\varnothing$  2.9 mm  $\pm$  0.05 / 0.11 in.  $\pm$  0.002, for aligning the printed circuit board (with cut-out marked a)
- 5 1 elongated hole for aligning the printed circuit board (with cut-out marked b)
- 6 4 holes  $\varnothing$  2.4 mm / 0.09 in. for clipping in adapter ZBZ01•

Dimensions An + 18.1 relate to the  $\varnothing$  2.4 mm  $\pm$  0.05 / 0.09 in.  $\pm$  0.002 holes for centring adapter ZBZ01•.

---

Electrical Composition Corresponding to Code C3

---

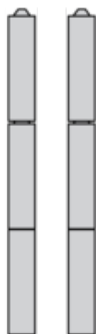

---

Electrical Composition Corresponding to Code C4

---

---

Electrical Composition Corresponding to Code C5

---

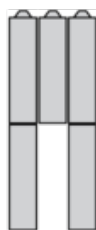

---

Electrical Composition Corresponding to Code C6

---

---

Electrical Composition Corresponding to Code C7

---



## Electrical Composition Corresponding to Code C8

---

## Electrical Composition Corresponding to Codes C9, C11, SF1 and SR1

---

## Electrical Composition Corresponding to Code C15

---

1 N/O

1 N/C

1 N/O + N/C or 1 N/O + N/O or 1 N/C + N/C

## Legend

---

Single contact

Double contact

Light block





Possible location



### Sequence of Contacts Fitted to 2-position Selector Switch Body

#### Position 315°



Push	Position	Top			
Bottom					
Location		Left	Centre	Right	
State		0	0	0	
Contacts	N/O		open	open	open
N/C		closed	closed	closed	

#### Position 45°



Push	Position	Top			
Bottom					
Location		Left	Centre	Right	
State		1	1	1	
Contacts	N/O		closed	closed	closed
N/C		open	open	open	