

ZB5AW313

Head for illuminated push button, Harmony XB5, plastic, white flush, 22mm, universal LED, spring return, plain lens



Galvenā

Produkta sērija	Harmony XB5
Produkta vai sastāvdaļas veids	Head for illuminated push-button
Ierīces īsais nosaukums	ZB5
Produkta saderība	Universal LED
Bezel material	Dark grey plastic
Mounting diameter	22 mm
Daudzums nedalāms	1
Head type	Standard
Shape of signaling unit head	Round
Type of operator	Spring return
Operator profile	White flush, unmarked
Operator additional information	With plain lens

Papildinošs

CAD overall width	29 mm
CAD overall height	29 mm
CAD overall depth	30 mm
Neto svars	0,017 kg
Resistance to high pressure washer	7000000 Pa 55 °C 0.1 m
Mehāniskā izturība	10000000 cikli
Main group	Illum push-button
Group of product	Flush push integral LED
Station name	XALD 1...5 cut-outs XALK 2...5 cut-outs
Cap/operator or lens colour	White
Marking	Unmarked
Electrical composition code	M1 6 single front mounting integral LED M2 6 single and double front mounting integral LED M6 2 single front mounting integral LED and transformer M10 2 single front mounting integral LED MF1 2 single front mounting integral LED MR1 2 single rear mounting integral LED
Ierīces komplektācija	Pamata apakšgrupas

Vide

Aizsargparklājumus	TC
Apkārtējā gaisa temperatūra uzglabāšanai	-40...70 °C
Apkārtējā gaisa temperatūra darbībai	-40...70 °C
Overvoltage category	Class II IEC 60536
IP degree of protection	IP66 IEC 60529 IP67 IP69 IP69K
NEMA degree of protection	NEMA 13 NEMA 4X

Triecienizturības klase (IK)	IK05 conforming to EN 50102
Standarti	UL 508 GB 14048.5 EN/IEC 60947-5-4 EN/IEC 60947-5-1 CSA C22.2 No 14 JIS C8201-5-1 EN/IEC 60947-1 JIS C8201-1
Produkta sertifikācija	DNV[RETURN]UL sarakstā[RETURN]LROS (Lloyds register of shipping) [RETURN]CSA[RETURN]BV[RETURN]GL
Vibration resistance	5 gn 2...500 Hz)IEC 60068-2-6
Shock resistance	30 gn 18 ms) half sine wave acceleration IEC 60068-2-27 50 gn 11 ms) half sine wave acceleration IEC 60068-2-27

Iepakojšanas vienības

Pirmā iepakojuma vienības tips	PCE
Vienību skaits 1. iepakojumā	1
1. iepakojuma augstums	4,400 cm
1. iepakojuma platums	3,400 cm
1. iepakojuma garums	5,100 cm
1. iepakojuma svars	17,000 g
Otrā iepakojuma vienības tips	BB1
Vienību skaits 2. iepakojumā	5
2. iepakojuma augstums	4,400 cm
2. iepakojuma platums	3,400 cm
2. iepakojuma garums	26,500 cm
2. iepakojuma svars	85,000 g
Trešā iepakojuma vienības tips	S03
Vienību skaits 3. iepakojumā	300
3. iepakojuma augstums	30,000 cm
3. iepakojuma platums	30,000 cm
3. iepakojuma garums	40,000 cm
3. iepakojuma svars	5,656 kg

Piedāvājiēt ilgtspēju

Ilgspējīgs piedāvājuma statuss	Green Premium izstrādājums
REACH regula	REACH Deklarācija
ES RoHS direktīva	Proaktīva atbilstība (uz izstrādājumu neattiecas ES RoHS juridiskās saistības)
Nesatur dzīvsudrabu	Jā
Ķīnas RoHS regula	Ķīnas RoHS Deklarācija
Informācija par RoHS izņēmumiem	Jā
Vides informācijas publiskošana	Produkta Ietekme Uz Vidi
Cirkularitātes profils	Informācija Par Ekspluatācijas Izbeigšanu
WEEE	Eiropas Savienības tirgū no šī produkta ir jāatbrīvojas, ievērojot noteiktu atkritumu savākšanas kārtību, un produkts nedrīkst nonākt sadzīves atkritumu tvertnēs.

Līguma garantija

Garantija	18 months
-----------	-----------

Dimensions

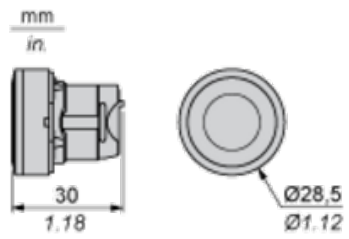

Panel Cut-out for Pushbuttons, Switches and Pilot Lights (Finished Holes, Ready for Installation)

Connection by Screw Clamp Terminals or Plug-in Connectors or on Printed Circuit Board



- (1) Diameter on finished panel or support
- (2) For selector switches and Emergency stop buttons, use of an anti-rotation plate type ZB5AZ902 is recommended.
- (3) $\varnothing 22.5$ mm recommended ($\varnothing 22.3_0^{+0.4}$) / $\varnothing 0.89$ in. recommended ($\varnothing 0.88$ in. $_0^{+0.016}$)

Connections	a in mm	a in in.	b in mm	b in in.
By screw clamp terminals or plug-in connector	40	1.57	30	1.18
By Faston connectors	45	1.77	32	1.26
On printed circuit board	30	1.18	30	1.18

Detail of Lug Recess



- (1) Diameter on finished panel or support
- (2) For selector switches and Emergency stop buttons, use of an anti-rotation plate type ZB5AZ902 is recommended.
- (3) $\varnothing 22.5$ mm recommended ($\varnothing 22.3_0^{+0.4}$) / $\varnothing 0.89$ in. recommended ($\varnothing 0.88$ in. $_0^{+0.016}$)

Pushbuttons, Switches and Pilot Lights for Printed Circuit Board Connection

Panel Cut-outs (Viewed from Installer's Side)

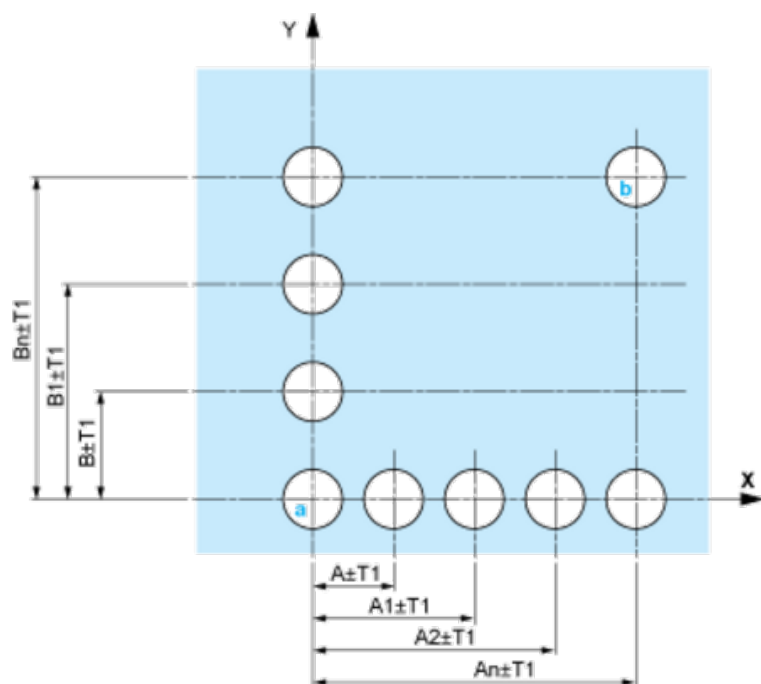

A: 30 mm min. / 1.18 in. min.

B: 40 mm min. / 1.57 in. min.

Printed Circuit Board Cut-outs (Viewed from Electrical Block Side)

Dimensions in mm

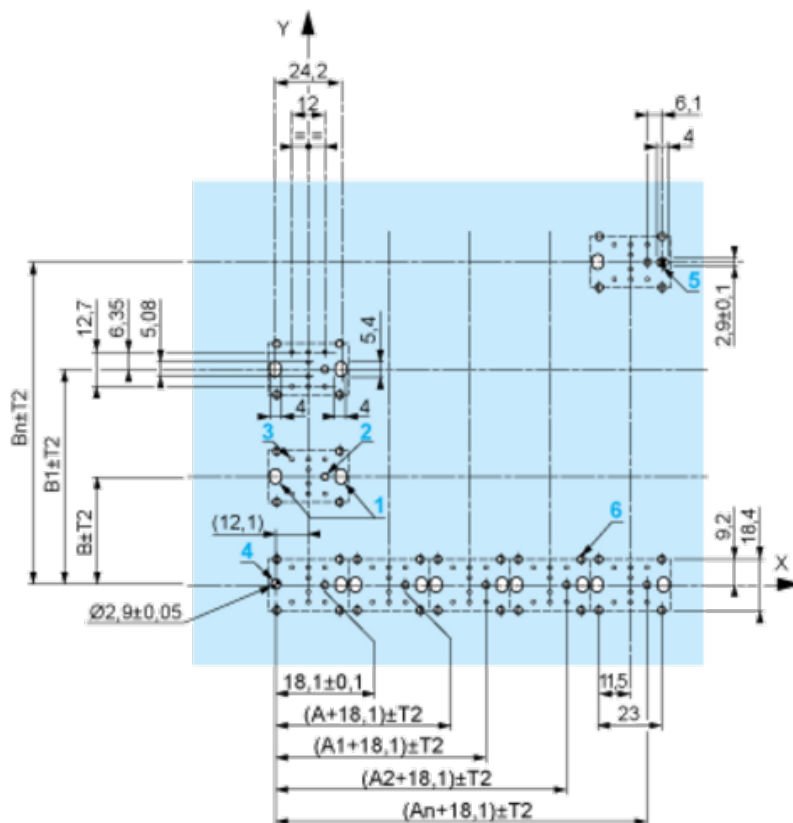

A: 30 mm min.

B: 40 mm min.

Dimensions in in.

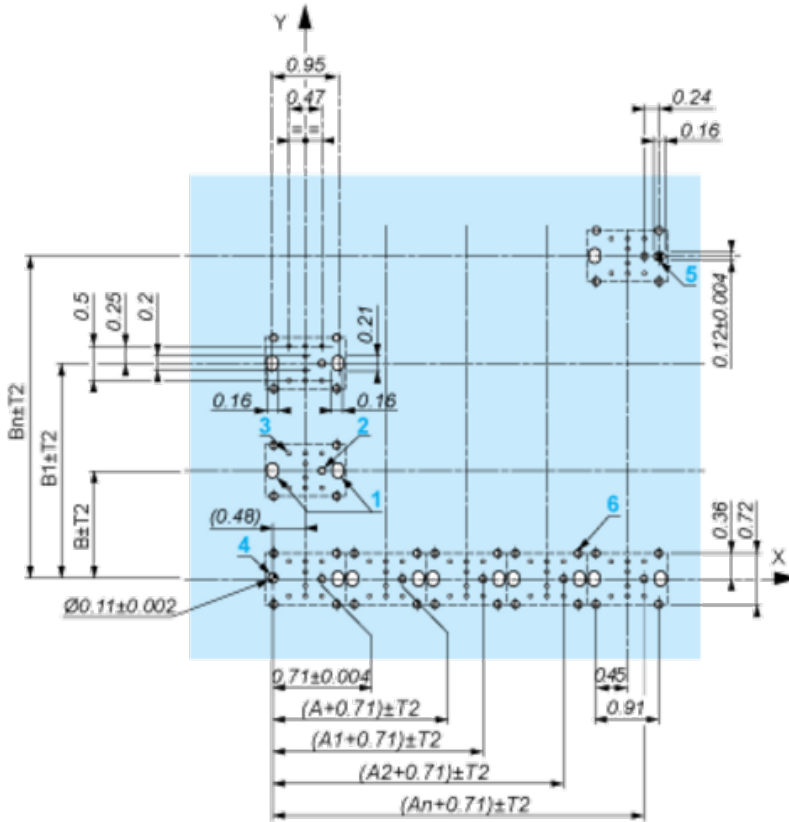

A: 1.18 in. min.
B: 1.57 in. min.

General Tolerances of the Panel and Printed Circuit Board

The cumulative tolerance must not exceed 0.3 mm / 0.012 in.: $T1 + T2 = 0.3 \text{ mm max.}$

Installation Precautions

- Minimum thickness of circuit board: 1.6 mm / 0.06 in.
- Cut-out diameter: 22.4 mm \pm 0.1 / 0.88 in. \pm 0.004
- Orientation of body/fixing collar ZB5AZ009: $\pm 2^\circ 30'$ (excluding cut-outs marked a and b).
- Tightening torque of screws ZBZ006: 0.6 N.m (5.3 lbf.in) max.
- Allow for one ZB5AZ079 fixing collar/pillar and its fixing screws:
 - every 90 mm / 3.54 in. horizontally (X), and 120 mm / 4.72 in. vertically (Y).
 - with each selector switch head (ZB5AD•, ZB5AJ•, ZB5AG•).

The fixing centers marked a and b are diagonally opposed and must align with those marked 4 and 5.



- (1) Head ZB5AD•
(2) Panel
(2) Nut

(4) Printed circuit board

Mounting of Adapter (Socket) ZBZ01•

- 1 2 elongated holes for ZBZ006 screw access
- 2 1 hole \varnothing 2.4 mm \pm 0.05 / 0.09 in. \pm 0.002 for centring adapter ZBZ01•
- 3 8 \times \varnothing 1.2 mm / 0.05 in. holes
- 4 1 hole \varnothing 2.9 mm \pm 0.05 / 0.11 in. \pm 0.002, for aligning the printed circuit board (with cut-out marked a)
- 5 1 elongated hole for aligning the printed circuit board (with cut-out marked b)
- 6 4 holes \varnothing 2.4 mm / 0.09 in. for clipping in adapter ZBZ01•

Dimensions An + 18.1 relate to the \varnothing 2.4 mm \pm 0.05 / 0.09 in. \pm 0.002 holes for centring adapter ZBZ01•.

Electrical Composition Corresponding to Codes M1 and M7

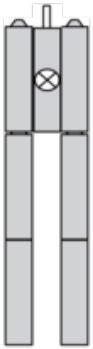

Electrical Composition Corresponding to Codes M2 and M8

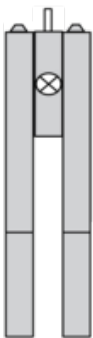

Electrical Composition Corresponding to Codes M6 and P2

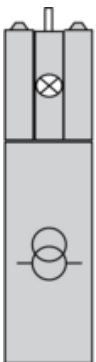

Electrical Composition Corresponding to Codes M5, M10, MF1, MR1 and MF2

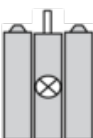

Legend

Single contact

Double contact

Light block

Possible location

