

Group Change-Over Switches Ex9BT3G



- Group Change-Over Switches
- Meet requirements of IEC EN 60947-3
- Rated current from 16 A to 40 A
- Rated operating voltage 240/415 V AC
- Utilization category AC-22A
- Contact form (I-O-II)
- 1 up to 4-pole versions
- Rated frequency 50/60 Hz

Group Change-Over Switches Ex9BT3G are designed and intended for switching of auxiliary, control, measuring and switching networks. Testing according 60947-3 standard ensure functions na reliability for wide variety of applications. Utilization category AC-22A allows switching under load.

They are available in variants with change-over contacts (CO) from 1 CO up to 4 CO.

Contact form (I-O-II) allows a load to be manually changed from one electrical source to another, without risk of short-circuit.

Type Key

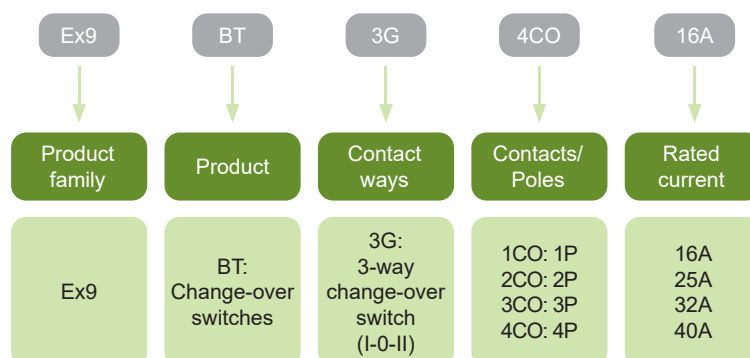

Certification marks



Group Change-Over Switches Ex9BT3G

1 Pole, 1 Change-over contact (I-O-II)



Rated current	Contacts	Contacts way	Article No.	Type	Packing
16 A	1 CO	(I-O-II)	113917	Ex9BT3G 1CO 16A	1/12/144
25 A	1 CO	(I-O-II)	113918	Ex9BT3G 1CO 25A	1/12/144
32 A	1 CO	(I-O-II)	113919	Ex9BT3G 1CO 32A	1/12/144
40 A	1 CO	(I-O-II)	113920	Ex9BT3G 1CO 40A	1/12/144

Wiring diagrams



2 Poles, 2 Change-over contacts (I-O-II)



Rated current	Contacts	Contacts way	Article No.	Type	Packing
16 A	2 CO	(I-O-II)	113921	Ex9BT3G 2CO 16A	1/6/72
25 A	2 CO	(I-O-II)	113922	Ex9BT3G 2CO 25A	1/6/72
32 A	2 CO	(I-O-II)	113923	Ex9BT3G 2CO 32A	1/6/72
40 A	2 CO	(I-O-II)	113924	Ex9BT3G 2CO 40A	1/6/72

Wiring diagrams

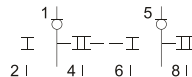

3 Poles, 3 Change-over contacts (I-O-II)



Rated current	Contacts	Contacts way	Article No.	Type	Packing
16 A	3 CO	(I-O-II)	113925	Ex9BT3G 3CO 16A	1/4/48
25 A	3 CO	(I-O-II)	113926	Ex9BT3G 3CO 25A	1/4/48
32 A	3 CO	(I-O-II)	113927	Ex9BT3G 3CO 32A	1/4/48
40 A	3 CO	(I-O-II)	113928	Ex9BT3G 3CO 40A	1/4/48

Wiring diagrams

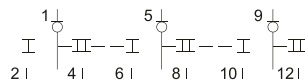

4 Poles, 4 Change-over contacts (I-O-II)



Rated current	Contacts	Contacts way	Article No.	Type	Packing
16 A	4 CO	(I-O-II)	113929	Ex9BT3G 4CO 16A	1/3/36
25 A	4 CO	(I-O-II)	113930	Ex9BT3G 4CO 25A	1/3/36
32 A	4 CO	(I-O-II)	113931	Ex9BT3G 4CO 32A	1/3/36
40 A	4 CO	(I-O-II)	113932	Ex9BT3G 4CO 40A	1/3/36

Wiring diagrams

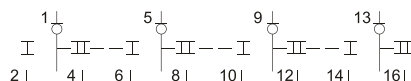

Technical Data Ex9BT3G

Group Change-Over Switches

General parameters

Modular change-over switches for switching of auxiliary, control, measuring and other circuits
Utilization category AC-22A
Contact form (I-O-II) allows a load to be manually changed from one electrical source to another and vice – versa
Suitable for household as well as industrial applications

Electrical parameters

Tested according to	IEC EN 60947-3
Rated op. voltage	240 / 415 V AC
Rated frequency	50/60 Hz
Rated current I _e	16, 25, 32, 40A
Number of contacts	1, 2, 3, 4
Utilization category	AC-22A
Rated insulation voltage U _i	690 V
Maximum back-up fuse	125 A gG
Mechanical service life	8 500 operation cycles
Electrical service life	1 500 operation cycles

Mechanical parameters

Device width	17.8 mm per pole
Device height	82 mm (88 mm including rail clip)
Frame size	45 mm
Mounting	easy fastening onto 35 mm device rail (DIN)
Degree of protection	IP20
Contact form	I-O-II
Terminals	lift
Terminal capacity	2.5 — 10 mm ²
Fastening torque of terminals	2.5 Nm
Ambient temperature	-5 — +40 °C
Altitude	≤ 2000 m
Relative humidity	≤ 95 %
Resistance to humidity and heat	class 2
Pollution degree	2
Installation class	III
Weight	0.073 kg (1 pole), 0.145 kg (2 pole), 0.218 kg (3 pole), 0.289 kg (4 pole)

Technical Data Ex9BT3G

Group Change-Over Switches

Dimensions

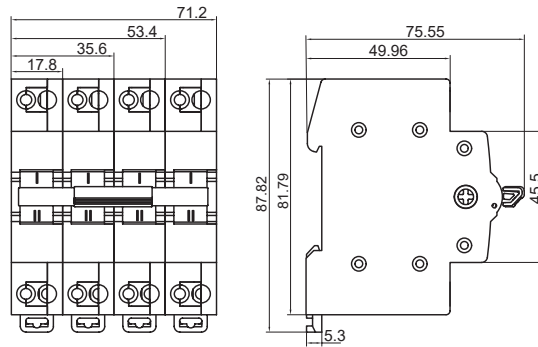

Wiring diagrams

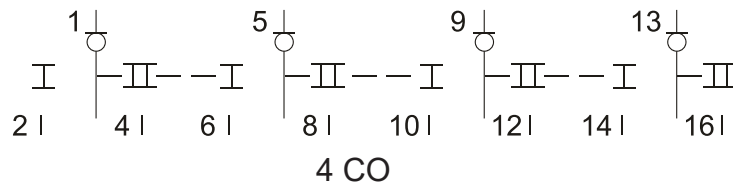
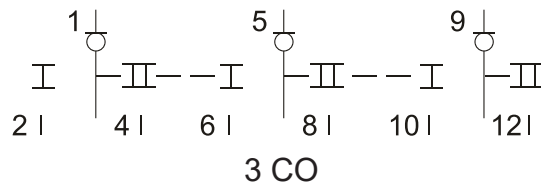
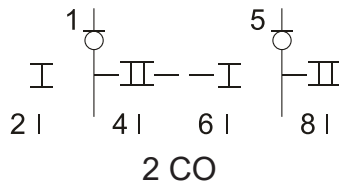
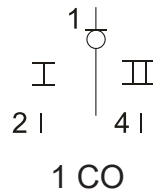

Power loss

Poles	Rated current (A)			
	16 A	25 A	32A	40 A
1P	0.3 W	0.7 W	1.2 W	1.8 W
2P	0.6 W	1.4 W	2.4 W	3.6 W
3P	0.9 W	2.1 W	3.6 w	5.4 W
4P	1.2 W	2.8 W	4.8 W	7.2 W