

# PHILIPS

Afterglow



User manual  
Benutzerhandbuch  
Notice d'emploi  
Manual de usuario  
Manual do usuário  
Manuale d'uso  
Gebruiksaanwijzing

Incl.

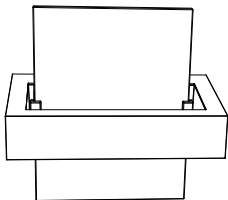

Excl.

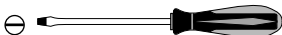
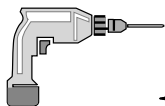

IP44

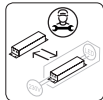
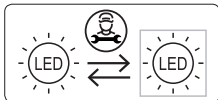
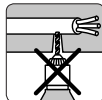
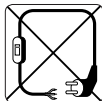
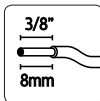
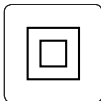
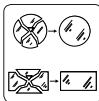

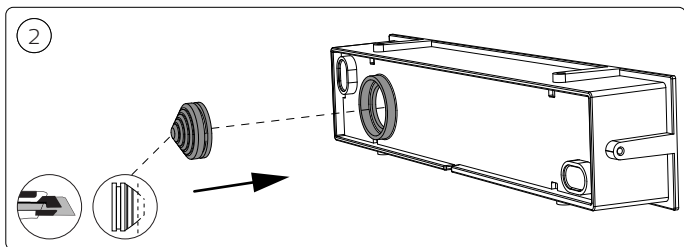
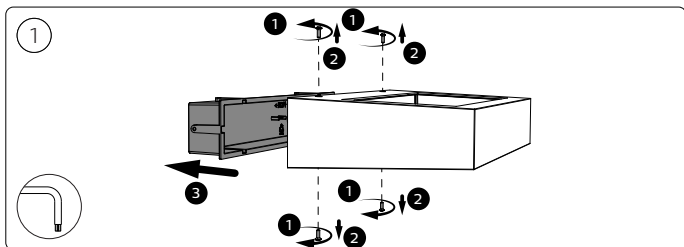
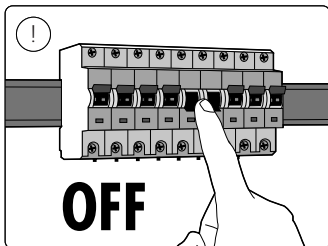
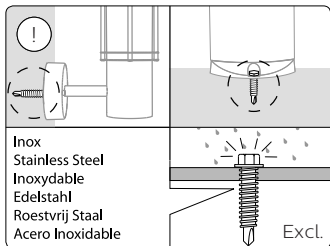

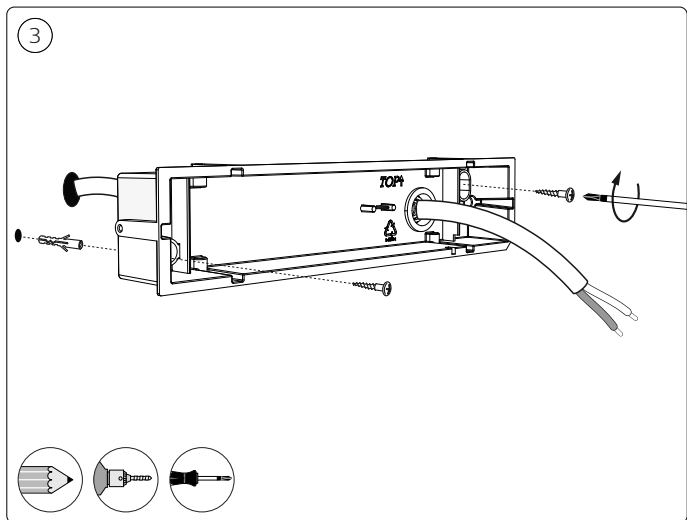
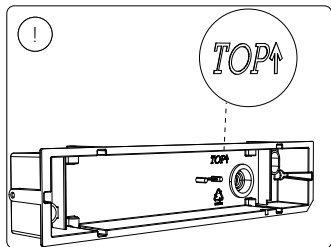



Not OK

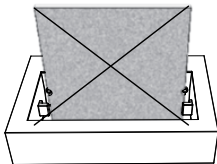

OK

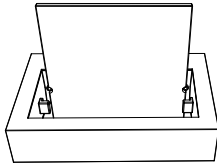

4

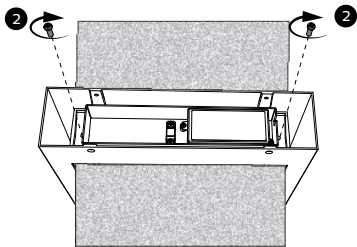
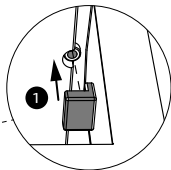
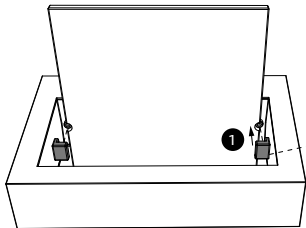

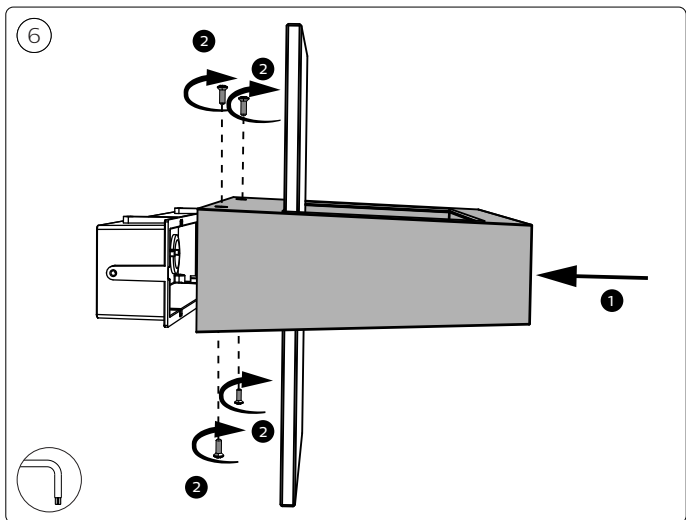
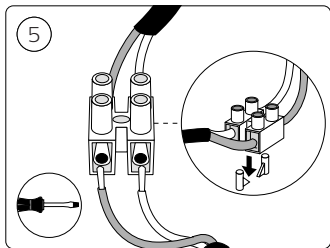

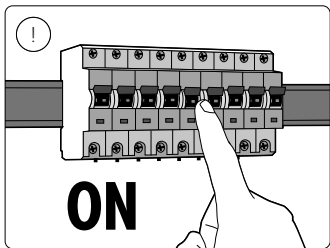
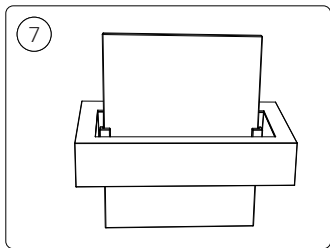



Signify  
I.B.R.S. / C.C.R.I. Numéro 10461  
5600 VB Eindhoven,  
the Netherlands  
☎00800-74454775

© 2021 Signify Holding  
All rights reserved

[www.philips.com/lighting](http://www.philips.com/lighting)

17352/\*\*/PO  
4404 029 06553  
Last update: 04/2021