

# PRODUCT DATASHEET

## DL ALU DALI DN 150 14 W 6500 K IP44/IP20 WT

DOWNLIGHT ALU DALI | Downlight luminaires with aluminum housing and DALI driver



---

### Areas of application

- Direct replacement for luminaires with compact fluorescent lamps
- General illumination
- Public areas
- Stairways
- Corridors
- Foyers
- Shops

---

### Product benefits

- Advanced functionality due to already included DALI driver
- DALI driver with individual luminaire current set-up already installed
- High luminous efficacy
- Energy savings up to 60 % (compared to luminaires that use CFL lamps)
- Very homogenous light
- Functional design
- Easy installation with fast connection
- 5 years guarantee

---

### Product features



- Advanced applications with DALI light installations
- Diameter of required ceiling cut-out: 150 mm or 200 mm (depending on version)
- Type of protection: IP44

## TECHNICAL DATA

### Electrical data

Nominal wattage	14.00 W
Nominal voltage	220...240 V
Mains frequency	0/50/60 Hz
Nominal current	100.000 mA
Inrush current	20 A
Inrush current time $T_{h50}$	140 $\mu$ s
Max. no. of lum. on circuit break. B16 A	32
Max. no. of lum. on circuit break. C10 A	31
Max. no. of lum. on circuit break. C16 A	53
Power factor $\lambda$	> 0.90
Total harmonic distortion	< 20 %
Protection class	II
Operating mode	External LED driver

### Photometrical data

Luminous flux	1330 lm
Luminous efficacy	95 lm/W
Color temperature	6500 K
Light color (designation)	Cool Daylight
Color rendering index Ra	> 80
Standard deviation of color matching	< 6 sdc <sub>m</sub>
Luminous intensity	-
Flickering metric (Pst LM)	-
Stroboscope effect metric (SVM)	-
Photobiological safety group acc. to EN62778	RG0
Photobiological safety group acc. to EN62471	RG0
Beam angle	100 °

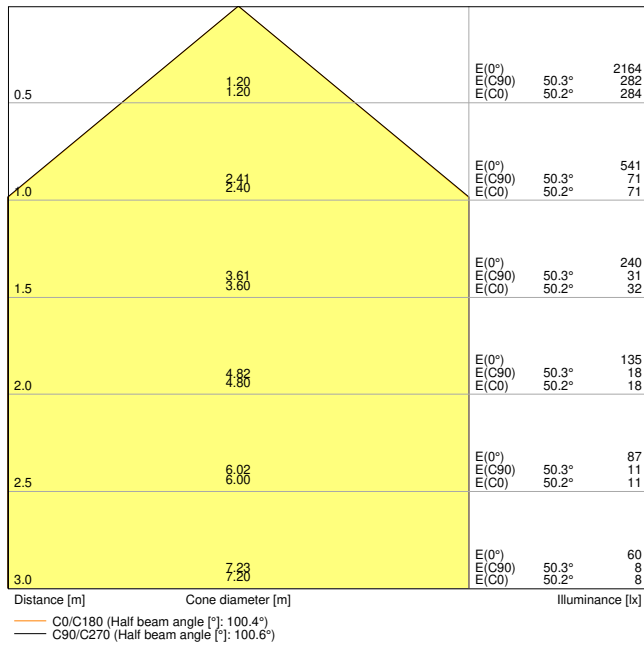

LDC typ cone

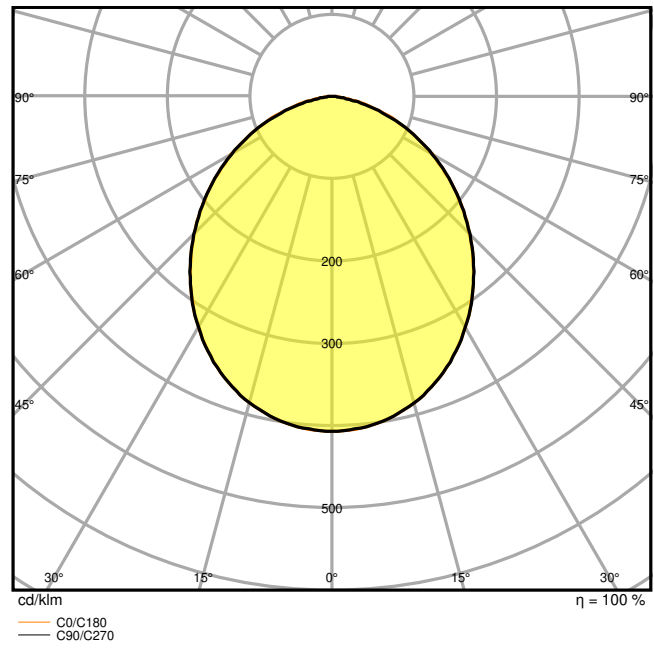

LDC typ polar

Dimensions & Weight

Diameter	160.00 mm
Height	52.00 mm
Product weight	360.00 g

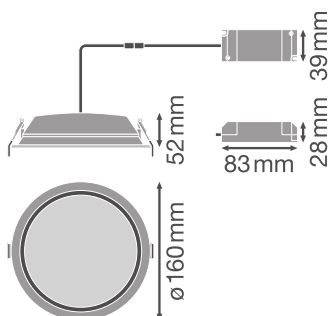

Materials & Colors

Product color	White
---------------	-------

Housing color	White
Body material	Aluminum
Cover material	Polymethylmethacrylate (PMMA)
Glow Wire Test according to IEC 60695-2-12	650 °C
Mercury content	0.0 mg

### Application & Mounting

Ambient temperature range	-20...+45 °C
Type of connection	Screwless terminal, 5-Pole
Type of protection	IP44/IP20
Protection class IK (shock resistance)	IK02
Dimmable	Yes
Type of dimming	DALI
Mounting type	Recessed
Mounting location	Ceiling
Application environment	Indoor
Mounting diameter	150 mm
Mounting depth	100 mm
LED module replaceable	Not replaceable
With light source	Yes

### Lifespan

Lifespan L70/B50 at 25 °C	50000 h
Lifespan L80/B10 at 25 °C	45000 h
Lifespan L90/B10 at 25 °C	30000 h
Number of switching cycles	100000





### Certificates & Standards







Standards	CE / CB / EAC
Luminaire with limited surface temperature, "D sign"	No
Ball shot safe	No



### Additional product data

Number of illuminants	Not relevant
-----------------------	--------------

### DOWNLOAD DATA

Documents and certificates	
	User instruction
	Addon Technical Information
	Declarations Of Conformity CE
	Declarations Of Conformity UKCA

Photometric and lighting design files	
	IES file (IES)
	LDT file (Eulumdat)
	ULD file (DIALux)
	ROLF file (RELUX)
	UGR file (UGR table)
	LDC typ cone
	LDC typ polar

CAD/BIM files	
	BIM_Revit_3D
	CAD_STEP_3D

Tender texts	
	Tender documents

**LOGISTICAL DATA**

Product code	Packaging unit (Pieces/Unit)	Dimensions (length x width x height)	Gross weight	Volume
4058075202658	Folding box 1	322 mm x 222 mm x 114 mm	525.00 g	8.15 dm <sup>3</sup>
4058075202665	Shipping box 8	658 mm x 466 mm x 263 mm	4955.00 g	80.64 dm <sup>3</sup>

The mentioned product code describes the smallest quantity unit which can be ordered. One shipping unit can contain one or more single products. When placing an order, for the quantity please enter single or multiples of a shipping unit.

---

### ADDITIONAL CATALOG INFORMATION

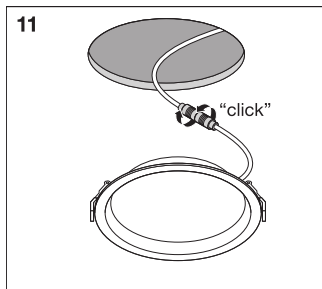

### References / Links

– For Guarantee see [www.ledvance.com/guarantee](http://www.ledvance.com/guarantee)

---

### DISCLAIMER

Subject to change without notice. Errors and omission excepted. Always make sure to use the most recent release.