

# PRODUCT DATASHEET

## DL UGR19 PFM DN195 21 W 830 WT IP54 DALI

DOWNLIGHT UGR19 DALI | Low-glare downlights, suitable for computer screen workstations with DALI-2 IoT technology



### Areas of application

- Suitable for office applications, especially for computer screen workplaces
- Direct replacement for luminaires with compact fluorescent lamps
- Entrances / Hallways
- Bathrooms, kitchens and sheltered outdoor areas
- General illumination

### Product benefits

- Suitable luminaire for VIVARES and other DALI-2 Light Management Systems
- Good glare reduction (UGR < 19) and cut off angle up to 30° for comfortable indoor lighting
- Easy and quick installation thanks to connector box with 5-pole toolless terminal
- Low flicker light
- Suitable for use in dusty and damp locations thanks to high IP rating
- 5 years guarantee

### Product features

- IoT-ready luminaire with DALI-2 technology
- Housing material: Aluminum mirror-finished reflector
- Type of protection: IP54 (room side) / IP20 (back side)
- Connector box with push wire terminal for tool-free connection
- Through-wiring possible



## TECHNICAL DATA

### Electrical data

Nominal wattage	21.00 W
Nominal voltage	220...240 V
Mains frequency	0/50/60 Hz
Nominal current	155 mA
Inrush current	15 A
Inrush current time $T_{h50}$	200 $\mu$ s
Max. no. of lum. on circuit break. B16 A	120
Max. no. of lum. on circuit break. C10 A	80
Max. no. of lum. on circuit break. C16 A	120
Power factor $\lambda$	$\geq 0.90$
Total harmonic distortion	< 10 %
Protection class	II
Operating mode	External LED driver

### Photometrical data

Luminous flux	2400 lm
Luminous efficacy	115 lm/W
Color temperature	3000 K
Light color (designation)	Warm White
Color rendering index Ra	$\geq 80$
Standard deviation of color matching	$\leq 5$ sdc <sub>m</sub>
Luminous intensity	-
Low flicker	Yes
Flickering metric (Pst LM)	-
Stroboscope effect metric (SVM)	-
Photobiological safety group acc. to EN62778	RG1
Photobiological safety group acc. to EN62471	RG0
Beam angle	65 °
UGR	< 19

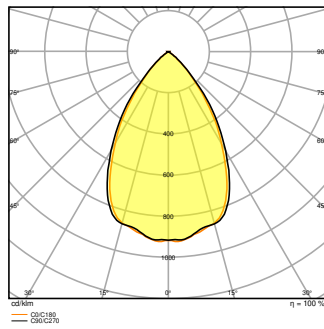
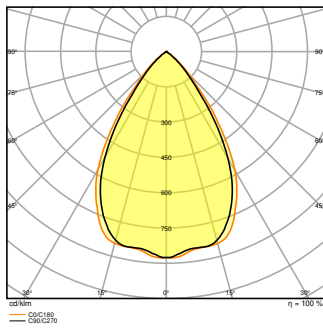
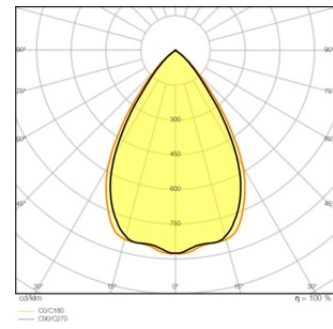
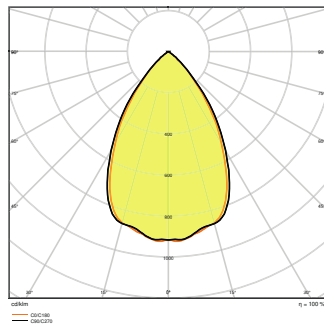
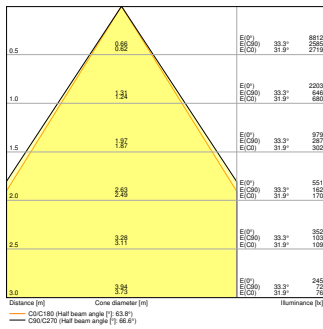
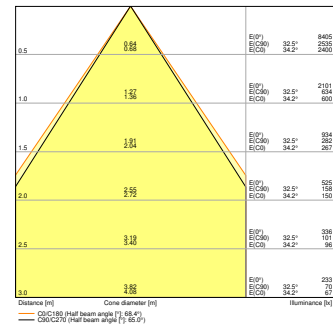
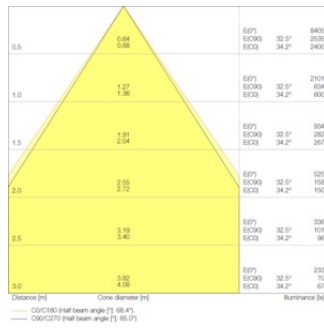
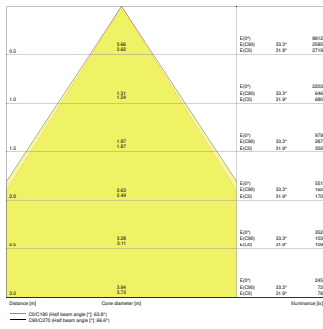

### Dimensions & Weight

Diameter	220.00 mm
Height	82.00 mm
Product weight	900.00 g

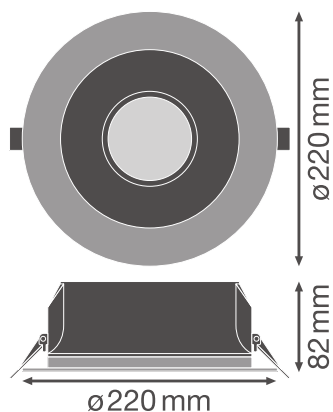

### Materials & Colors

Product color	White
Housing color	White
Body material	Aluminum
Cover material	Polycarbonate (PC)
Light emitting surface material	Polycarbonate (PC)
Glow Wire Test according to IEC 60695-2-12	650 °C
Mercury content	0.0 mg

### Application & Mounting

Ambient temperature range	-20...+45 °C
Temperature range at storage	-40...+70 °C
Type of connection	Screwless terminal, 5-Pole (L, N, PE, DA+, DA-)
Type of protection	IP54/IP20
Protection class IK (shock resistance)	IK03
Dimmable	Yes
Type of dimming	DALI
Mounting type	Recessed
Mounting location	Ceiling
Application environment	Indoor
Mounting diameter	195,0 mm
Mounting depth	120 mm
LED module replaceable	Not replaceable
With light source	Yes

### Lifespan

Lifespan L70/B50 at 25 °C	70000 h
Lifespan L80/B10 at 25 °C	60000 h
Lifespan L90/B10 at 25 °C	40000 h
Number of switching cycles	100000

### Control gear

Output current	700 mA
ECG - Output ripple current	< 10 %
ECG - Length	119.0 mm
ECG - Width	52.0 mm
ECG - Height	30 mm

### Certificates & Standards

Standards	CE / CB / ENEC / TÜV SÜD / EAC
Luminaire with limited surface temperature, "D sign"	No
Ball shot safe	No





### Additional product data

Number of illuminants	Not relevant
-----------------------	--------------







### EQUIPMENT / ACCESSORIES

- External control gear included

### DOWNLOAD DATA

Documents and certificates	
	User instruction
	Addon Technical Information
	Packaging insert
	Declarations Of Conformity CE
	Declarations Of Conformity UKCA

**Photometric and lighting design files**

	IES file (IES)
	LDT file (Eulumdat)
	ULD file (DIALux)
	ROLF file (RELUX)
	UGR file (UGR table)
	LDC typ cone
	LDC typ polar

**CAD/BIM files**

	BIM_Revit_3D
	CAD_STEP_3D

**Tender texts**

	Tender documents
---	------------------

**LOGISTICAL DATA**

Product code	Packaging unit (Pieces/Unit)	Dimensions (length x width x height)	Gross weight	Volume
4058075459830	Folding box 1	262 mm x 108 mm x 266 mm	1197.00 g	7.53 dm <sup>3</sup>
4058075459847	Shipping box 16	545 mm x 452 mm x 563 mm	20749.00 g	138.69 dm <sup>3</sup>

The mentioned product code describes the smallest quantity unit which can be ordered. One shipping unit can contain one or more single products. When placing an order, for the quantity please enter single or multiples of a shipping unit.

**ADDITIONAL CATALOG INFORMATION**

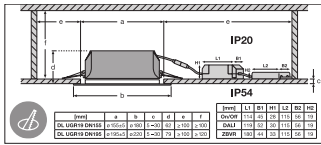
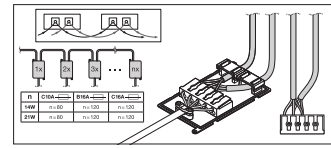
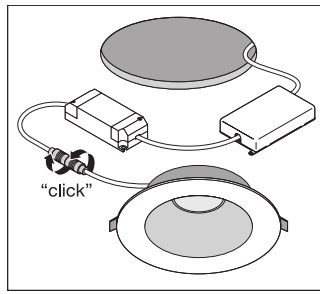
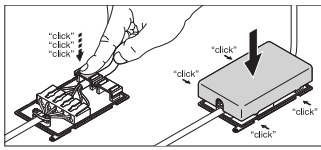

## References / Links

– For Guarantee see [www.ledvance.com/guarantee](http://www.ledvance.com/guarantee)

## DISCLAIMER

Subject to change without notice. Errors and omission excepted. Always make sure to use the most recent release.