

# PRODUCT DATASHEET

## DL IP44 DN 90 4W 840 WT

DOWNLIGHT IP44 | Downlights with IP44 grade



---

### Areas of application

- Direct replacement for luminaires with fluorescent lamps
- General illumination
- Public areas
- Stairways
- Corridors
- Shops
- Bathrooms

---

### Product benefits

- High luminous efficacy
- Very homogenous light
- Simple installation thanks to integrated driver

---

### Product features

- Type of protection: IP44
- Luminous efficacy: 100 lm/W



---

**TECHNICAL DATA****Electrical data**

Nominal wattage	4.00 W
Nominal voltage	220...240 V
Mains frequency	50...60 Hz
Nominal current	30.000 mA
Inrush current	4.4 A
Inrush current time $T_{h50}$	250 $\mu$ s
Max. no. of lum. on circuit break. B16 A	373
Max. no. of lum. on circuit break. C10 A	200
Max. no. of lum. on circuit break. C16 A	320
Power factor $\lambda$	0.50
Total harmonic distortion	< 80 %
Protection class	II
Operating mode	Integrated LED driver

**Photometrical data**

Luminous flux	400 lm
Luminous efficacy	100 lm/W
Color temperature	4000 K
Light color (designation)	Cool White
Color rendering index Ra	> 80
Standard deviation of color matching	< 6 sdc <sub>m</sub>
Low flicker	Yes
Photobiological safety group acc. to EN62778	RG0
Photobiological safety group acc. to EN62471	RG0
Beam angle	100 °

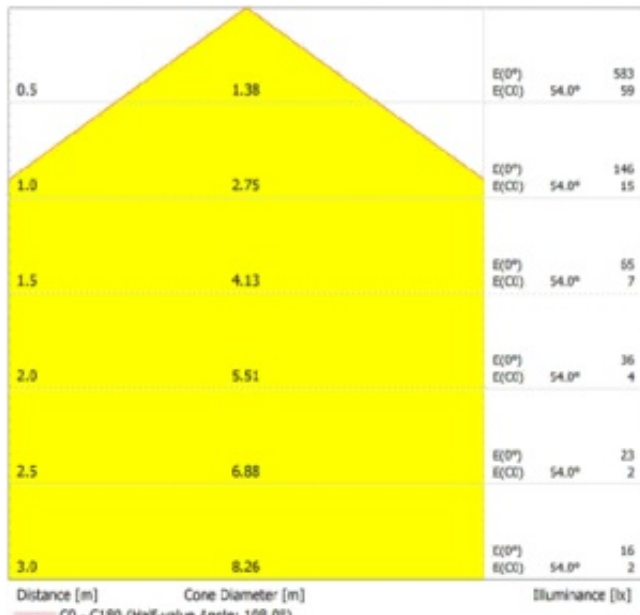

LDC typ cone

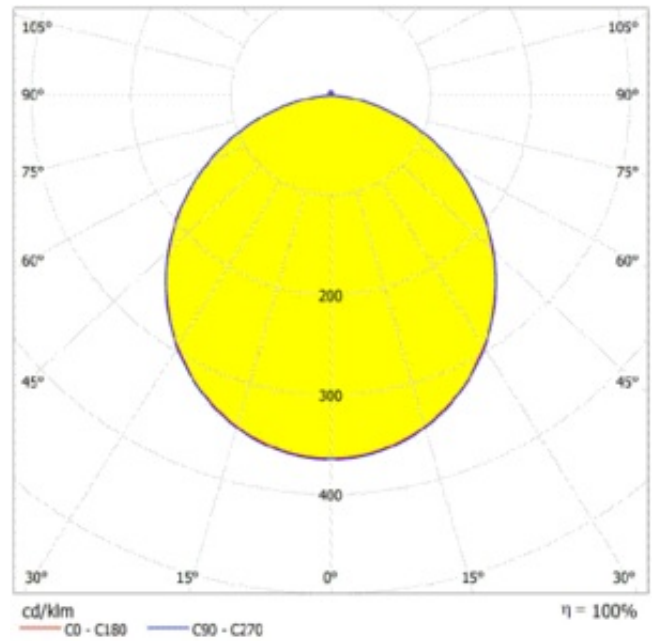

LDC typ polar

Dimensions & Weight

Diameter	90.00 mm
Height	42.00 mm
Product weight	50.00 g

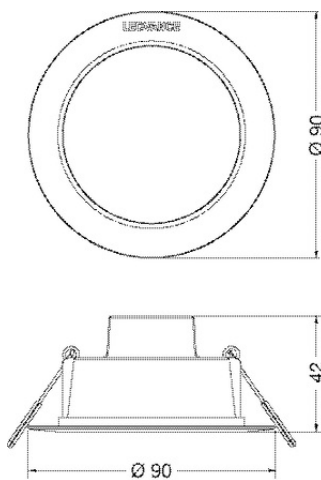

## Materials & Colors

Product color	White
Housing color	White
Body material	Polycarbonate (PC)
Cover material	Polycarbonate (PC)
Light emitting surface material	Polycarbonate (PC)
Glow Wire Test according to IEC 60695-2-12	650 °C
Mercury content	0.0 mg

## Application & Mounting

Ambient temperature range	-20...+40 °C
Temperature range at storage	-20...+80 °C
Type of connection	Cable, 2-pole
Type of protection	IP44
Protection class IK (shock resistance)	IK03
Dimmable	No
Mounting type	Recessed
Mounting location	Ceiling
Application environment	Indoor
Mounting diameter	75 mm
Mounting depth	40 mm
Adjustable	No
LED module replaceable	Not replaceable
With light source	Yes

## Lifespan

Lifespan L70/B50 at 25 °C	20000 h
Lifespan L80/B10 at 25 °C	18000 h
Lifespan L90/B10 at 25 °C	15000 h
Number of switching cycles	100000

## Control gear

Output current	66 mA
ECG - Output ripple current	< 5 %













## Certificates & Standards

Standards	CE / EMC / ROHS 2.0 / REACH
Luminaire with limited surface temperature, "D sign"	No
Ball shot safe	No

## EQUIPMENT / ACCESSORIES

- Surface mounting frames available as accessories

## DOWNLOAD DATA

Documents and certificates	
	User instruction
	Addon Technical Information
	Packaging insert
	Declarations Of Conformity CE
	Declarations Of Conformity UKCA
Photometric and lighting design files	
	IES file (IES)
	LDT file (Eulumdat)
	ULD file (DIALux)
	ROLF file (RELUX)
	UGR file (UGR table)
	LDC typ cone
	LDC typ polar

CAD/BIM files



BIM\_Revit\_3D



CAD\_STEP\_3D

Tender texts



Tender documents

LOGISTICAL DATA

Product code	Packaging unit (Pieces/Unit)	Dimensions (length x width x height)	Gross weight	Volume
4058075702882	Folding box 1	95 mm x 51 mm x 95 mm	83.00 g	0.46 dm <sup>3</sup>
4058075702899	Shipping box 10	269 mm x 200 mm x 111 mm	842.00 g	5.97 dm <sup>3</sup>

The mentioned product code describes the smallest quantity unit which can be ordered. One shipping unit can contain one or more single products. When placing an order, for the quantity please enter single or multiples of a shipping unit.

ADDITIONAL CATALOG INFORMATION

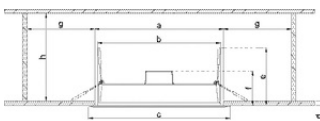

Model	a [mm]	b [mm]	c [mm]	d [mm]	e [mm]	f [mm]	g [mm]	h [mm]
DL IP44 DN90	Ø 75	Ø 58	Ø 90	3-25	65	40	100	170
DL IP44 DN116	Ø 100	Ø 80	Ø 116	3-25	65	40	100	170
DL IP44 DN165	Ø 160	Ø 140	Ø 165	3-25	65	40	100	170
DL IP44 DN190	Ø 116	Ø 105	Ø 190	3-25	65	40	100	170
DL IP44 DN216	Ø 200	Ø 194	Ø 216	3-25	65	40	160	170

DISCLAIMER

Subject to change without notice. Errors and omission excepted. Always make sure to use the most recent release.