



## SWITCH & ENERGY

Wi-R1S1-P

1-channel relay  
with monitoring function  
network parameters



---

[www.fif.com.pl/fox/switchenergy](http://www.fif.com.pl/fox/switchenergy)

---



F&F Filipowski sp. j.; Konstantynowska 79/81, 95-200 Pabianice, POLAND  
[www.fif.com.pl](http://www.fif.com.pl); e-mail: [biuro@fif.com.pl](mailto:biuro@fif.com.pl)

---

### System capabilities

- » Communication via home Wi-Fi network;
- » Remote access to devices via the Polish F&F cloud;
- » Integration with Google and Google Home voice assistant;
- » Ability to work autonomously, without a Wi-Fi connection;
- » Advanced programmable timers based on online calendars and enhanced with astronomical functions;
- » Free mobile applications for Android and iOS.

## Properties

- » 1-channel 230 V relay with 10 A rated capacity and 16 A maximum capacity;
- » Ability to connect local control button and set its function;
- » Monitoring of network parameters: voltage, current, power (active and reactive), energy (active and reactive);
- » Controlling receivers with a mobile app and time programmers;
- » Built-in clock with power backup and backup copy of the work program guarantees proper operation also without a Wi-Fi connection;
- » REST API support enabling integration of the controller also with other home automation systems;
- » Built-in thermal protection;
- » Convenient installation in an installation box with a diameter of  $\varnothing 60$  mm.



The ability to operate at loads above the rated value depends on the temperature and operating conditions of the device. Prolonged operation at such high load may lead to tripping of the thermal protection and disconnection of the controlled circuits.

---

## Configuration

For the initial configuration of the Fox module, it is necessary to download and run the free Fox application available for mobile devices running the system:

- » Android, version 6.0 or higher;
- » iOS, version 12 or higher.

You can download the app directly from the stores:



or via the website:

[www.fif.com.pl/fox](http://www.fif.com.pl/fox)



On the above page, you can also find detailed information on how to configure and operate the devices and the Fox mobile app.

## Wiring diagram

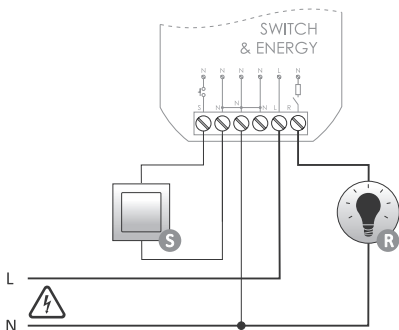

### Description of terminals

- S local control button input  
(default – R ON/OFF function)
- N power supply – neutral wire  
(3×N terminals connected inside of the device)
- L power supply – phase wire
- R power output for R receiver



It is recommended to use monostable (momentary) buttons. When using bistable buttons, at most one pushbutton can be connected to the input.



Switch&Energy controller is not adapted to work with backlit buttons.

---

## First launch

After connecting the device to the power supply, it is recommended to personalize the device.

Personalization is the process of assigning passwords to access the device and setting up a connection to the home Wi-Fi network and (optionally) remote access to the device via the F&F cloud.

---



Do not leave the device switched on without performing the personalization. There is a risk that another user of the Fox application will gain access to your device. If you lose access to your Fox device, follow the procedure described in **Restore factory settings** section.

---



For a detailed description of how to use the Fox application, see the context-sensitive help for the application (available under the „i” key in the mobile application) or go to [www.fif.com.pl/fox/switchenergy](http://www.fif.com.pl/fox/switchenergy).

---

1. Start the Fox application.
2. Open the program menu ( ≡ symbol in the upper left corner of the screen) and select the **Start** command.
3. In the system selection window, press the wireless system icon  and follow the directions in the following screens:

## – Remote access

Remote access configuration is necessary when you need to be able to access and control your Fox devices from outside your home when your phone app and Fox modules are not connected to the same local network. If you do not have a remote access account, create one by pressing **Create Account** button and following the instructions displayed by the application. If you are adding an existing account to the application, you need to enter its parameters into the application: email address used to create an account in the cloud and a password to access the cloud and add more devices. In the first field (**Name**), enter the name under which the account will be displayed in the application. After entering the data, press the **Add** button.

---



Adding an account is a one-time action. The created account is visible in the list at the bottom of the screen and can be used to personalize subsequent devices. In this case, you can skip the **Remote Access** screen by pressing the **Next** button.

---



Remote access can be set independently for each device in a further customization step. Lack of remote access does not block the functionality of the device, it can still be accessed within the local Wi-Fi network.

---

## – Password manager

Each Fox device allows you to enter two passwords: an administrator who has full configuration and device control rights, and a user who can control devices but without access to configuration settings.

First, add passwords to the password manager. One or two predefined passwords are then substituted for the personalized controllers. To add a new password to the password manager, you must:

- › In the **Enter name** field enter a description of the password under which it will be visible on the device manager list (such as Home administrator, living room user),
- › In the **Enter password** field, enter the content of the password,
- › Press the **Add** button.



The password is the key to access the device. Devices can be grouped using the same passwords, and permissions to these groups can be delegated in the form of an assigned access password. This way, by deciding which passwords go to which users, you can freely manage access to devices.



For more information on the role of passwords and their use in user management, go to: [www.fif.com.pl/fox](http://www.fif.com.pl/fox).



**To remove user rights to a selected device, change the access passwords on it.**

---



Deleting a password from the **Password Manager** will lose access to all devices using the deleted password.

---

– **Calendar manager**

Allows you to add links to online calendars that can be used to program the operating cycle of Fox controllers. More information can be found at: [www.fif.com.pl/fox](http://www.fif.com.pl/fox).

– **Search**

Based on the previously entered information (remote access and password list), the application will start searching for devices.

---



Before you start searching, you need to enable the Bluetooth function on your phone and agree to access the location. This will allow you to directly search for nearby Fox devices.

---

The app searches for:

- › available devices nearby that are in factory mode;
  - › devices available on your local network or connected to cloud accounts for which passwords were previously entered into **Password Manager**.
- 



The gray icon and gray device description indicate devices detected nearby via a Bluetooth connection. To add such a device click on the Bluetooth icon on the right side of the description and wait for the connection to be established. Once the connection is established, the icon and description turn white.

---

Pressing the "+" button adds device support to the application. For controllers in factory mode, the customization mechanism for the selected module is started here and the instructions in the **Device Configuration** window must be followed:

- › Enter the name under which the device will be displayed;
- › From the drop-down list of passwords, select the password for the administrator and user;
- › Set the parameters of the Wi-Fi network (network name and password) to which the device will connect;



Fox controllers can only connect to Wi-Fi networks operating in the 2.4 GHz band.

---

- › Set other configuration parameters as necessary: user password, remote access account, link to the programmers calendar, and the time zone and location of the device necessary for proper operation of the programmers;
- › After entering all the data, press the **OK** button and wait for the configuration to be sent to the device. The application will continuously display messages about the progress of saving the configuration and inform about possible errors;
- › When the configuration is saved correctly, the device disappears from the list of retrieved devices and is moved to the list of devices visible in the application.



If you personalize more devices, you can use the **Set Defaults** option at the top of the **Device Configuration** screen. Pressing this button will substitute all recently entered data (passwords, Wi-Fi settings, remote access, calendar, location and time zone) into the new device.

---

## LED signalling

The status of the module can be directly assessed by the STATUS light located on the front of the device.



The grey color actually corresponds to the green LED and the black color to the red LED.



Controller  
in factory mode

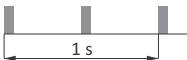

Connecting to  
a Wi-Fi network

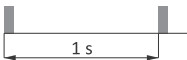

Connection to Wi-Fi  
network established

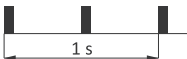

No connection  
to Wi-Fi network



Restoring firmware

## Restore factory settings

In case of lack of access to the controller, for example due to lost passwords, it is recommended that you reset the access passwords and then reconnect and configure the controller using the Fox application.

To reset passwords:

1. While the controller is operating, press and hold the PROG button on the front of the controller. When the button is pressed, the green LED will start to flash rapidly.
2. After about 5 seconds, the LED will turn off and you should release the PROG button.
3. Press the PROG button briefly, the green LED will light up again.
4. Press and hold down the PROG button. After about 3 seconds, the previously switched on green LED control light will start to flash. After another 3 seconds, it will go out and the red LED light up.
5. Release the button – after a few seconds the indicator LED will turn green and the controller will restart.
6. After completing this procedure, the access passwords and parameters for remote access have been cleared. You can now search for your device again in the app and personalize it again.

## Technical data

power supply	85÷265 V AC
control input	
control voltage	85÷265 V AC
control pulse current	<1 mA
maximum load current (AC-1)	
rated current	10 A
maximum current (instantaneous)	16 A
power consumption	
standby	<1,2 W
operation (relay on)	<2 W
communication	
radio frequency	2.4 GHz
transmission	Wi-Fi
radio power (IEEE 802.11n)	<13 dBm
receiver sensitivity	-98 dBm
terminal	2.5 mm <sup>2</sup> screw terminals
tightening torque	0.4 Nm
working temperature	0÷45°C
humidity	<90%
(no condensation of steam and aggressive gases)	
dimensions	∅54 (size 48×43 mm), h= 20 mm
mounting	in ∅60 flush-mounted box
ingress protection	IP20

## Warranty

F&F products are covered by a 24-month warranty from the date of purchase. The warranty is only valid with proof of purchase. Contact your dealer or contact us directly.

## CE declaration

F&F Filipowski sp. j. declares that the device is in conformity with the essential requirements of Directive 2014/53/EU of the European Parliament and of the Council of 16 April 2014 on the harmonisation of the laws of the Member States relating to the making available on the market of radio equipment and repealing Directive 1999/5/EC.

The CE Declaration of Conformity, along with the references to the standards in relation to which conformity is declared, can be found on [www.fif.com.pl](http://www.fif.com.pl) on the product page.

**«F&F»<sup>®</sup>**