

---

## DOWNLIGHT UGR19

---

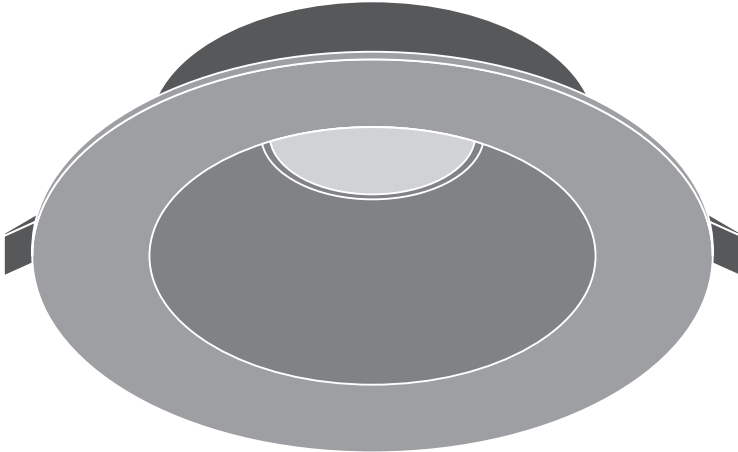

	EAN	Ø x h [mm]	W	V <sub>AC</sub>	Hz	lm	lm/W	K
DL UGR19 DN155 PFM 14W/840 ZBVR WT	4058075459892	180 x 65	14	220-240	50/60	1600	115	4000
DL UGR19 DN195 PFM 21W/840 ZBVR WT	4058075459397	220 x 82	21	220-240	50/60	2520	120	4000

	EAN	IP	IK	∠	R <sub>a</sub>	° (°C)	PF	👤
DL UGR19 DN155 PFM 14W/840 ZBVR WT	4058075459892	54/20	03	65°	≥ 80	-20...+45	≥ 0.9	0.7 kg
DL UGR19 DN195 PFM 21W/840 ZBVR WT	4058075459397	54/20	03	65°	≥ 80	-20...+45	≥ 0.9	0.9 kg

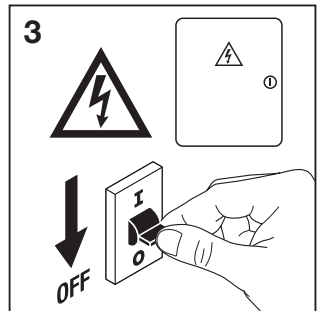
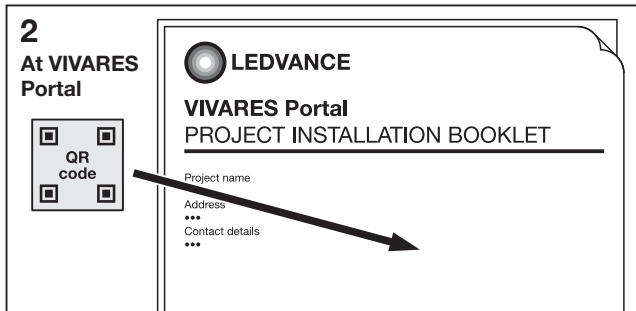
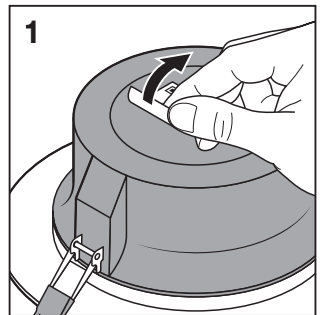
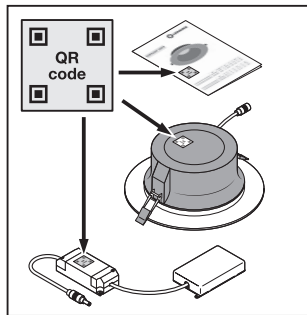
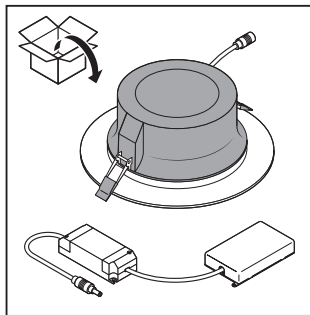
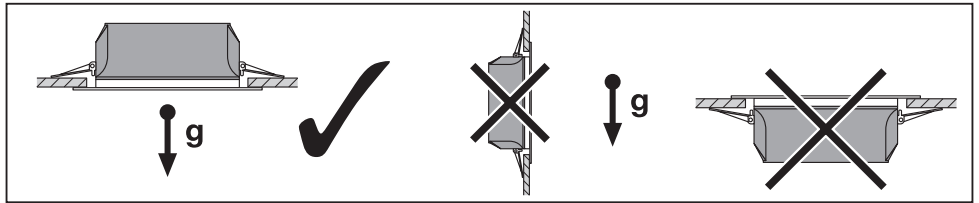
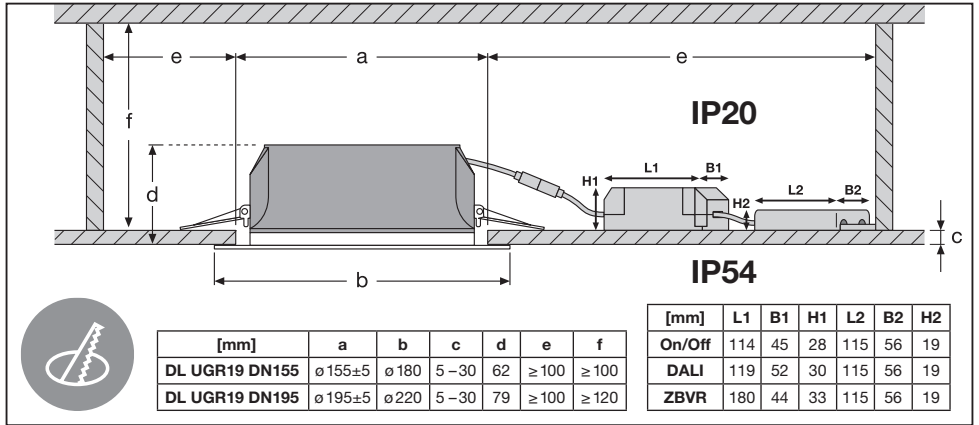

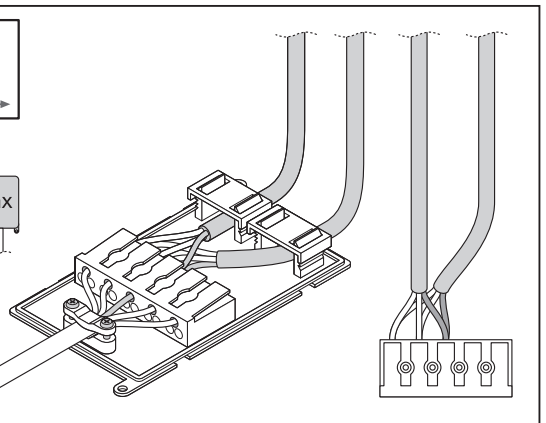
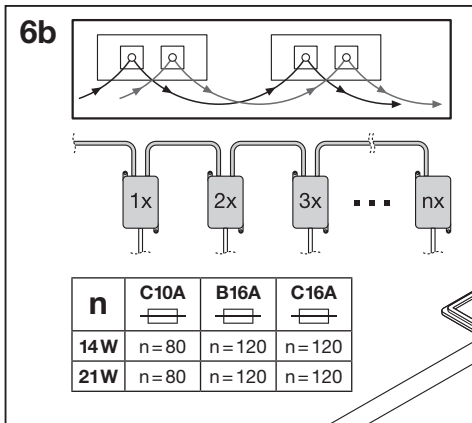
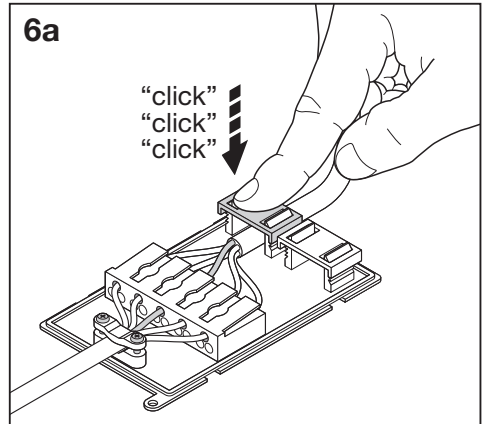
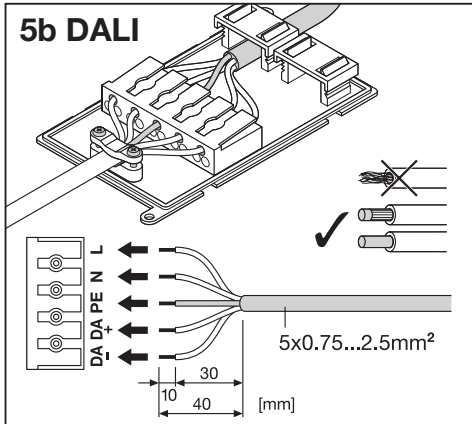
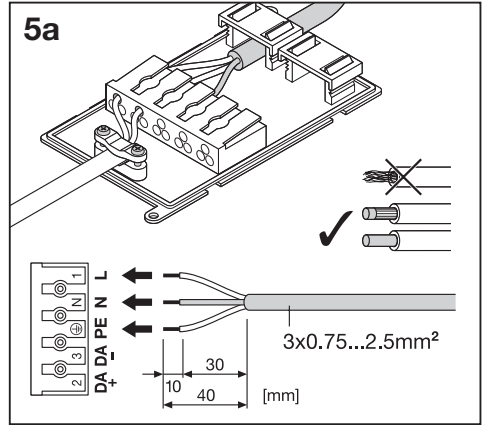
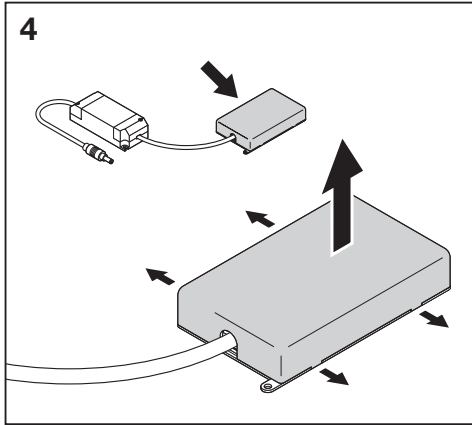

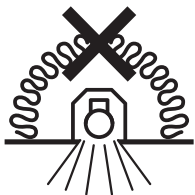
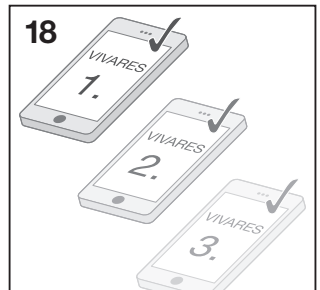
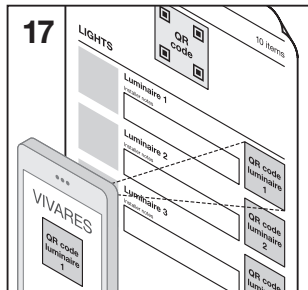
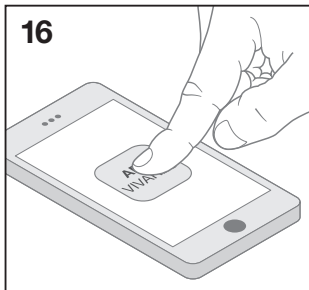
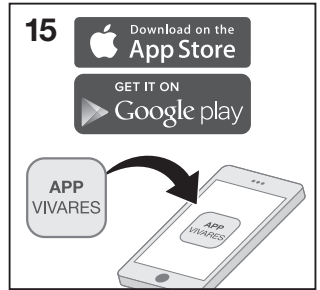
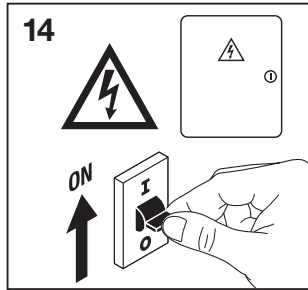
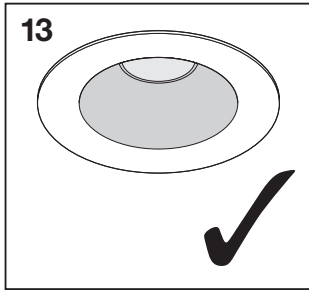
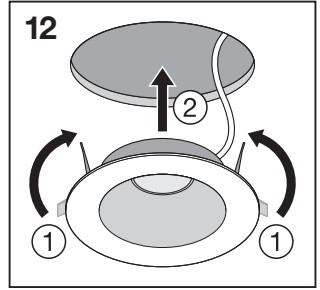
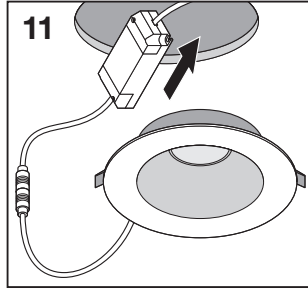
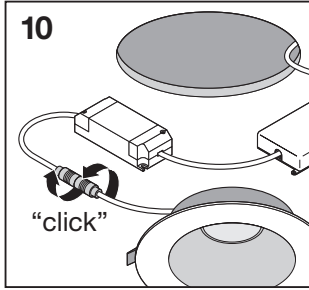
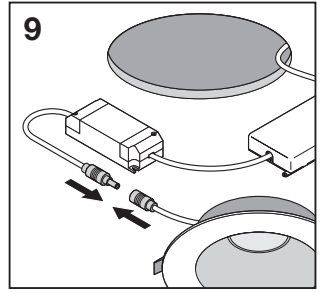
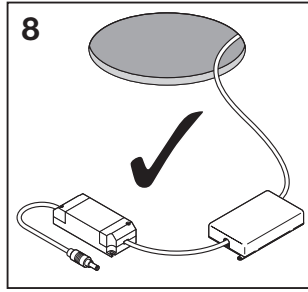
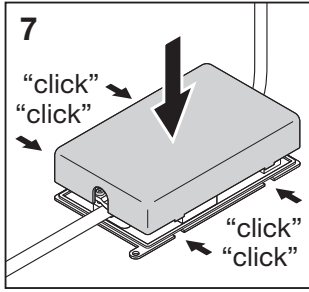

C10449057  
G11105669  
08.02.21



LEDVANCE GmbH  
Steinerne Furt 62  
86167 Augsburg, Germany  
[www.ledvance.com](http://www.ledvance.com)