

# PRODUCT DATASHEET

## PL COMP 600 V 33W 830 U19

PANEL COMPACT 600 UGR<19 | Square recessed panel luminaire with low glare, for 600 x 600 mm ceiling systems

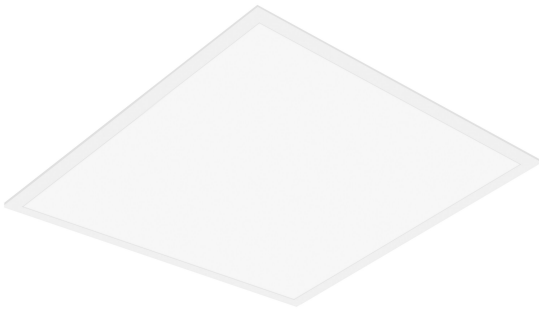

---

### Areas of application

- Direct replacement for luminaires with fluorescent lamps
- Offices, conference rooms
- Reception areas, foyers, corridors, elevators
- Suitable for recessed ceiling systems with grid size of 600 x 600 mm

---

### Product benefits

- Good glare reduction (UGR  $\leq$  19)
- Low flicker light thanks to special electronic control gear
- Energy savings thanks to system efficacy of up to 110 lm/W
- External driver for extended flexibility and easy installation
- Versions with DALI ECG available
- 5 years guarantee

---

### Product features

- Extruded aluminum frame
- Polystyrene diffuser
- Lifetime (L80/B10): up to 50,000 h (at 25 °C)



---

## TECHNICAL DATA

### Electrical data

Nominal wattage	33.00 W
Nominal voltage	220...240 V
Mains frequency	50...60 Hz
Nominal current	150.000 mA
Inrush current	12.3 A
Inrush current time $T_{h50}$	52 $\mu$ s
Max. no. of lum. on circuit break. B16 A	61
Max. no. of lum. on circuit break. C10 A	61
Max. no. of lum. on circuit break. C16 A	78
Power factor $\lambda$	> 0.90
Total harmonic distortion	< 10 %
Protection class	II
Operating mode	External LED driver

### Photometrical data

Luminous flux	3630 lm
Luminous efficacy	110 lm/W
Color temperature	3000 K
Light color (designation)	Warm White
Color rendering index Ra	> 80
Standard deviation of color matching	$\leq$ 5 sdc <sub>m</sub>
Low flicker	Yes
Flickering metric (Pst LM)	<1
Stroboscope effect metric (SVM)	< 0.4
Photobiological safety group acc. to EN62778	RG0
Beam angle	90 °
UGR	< 19



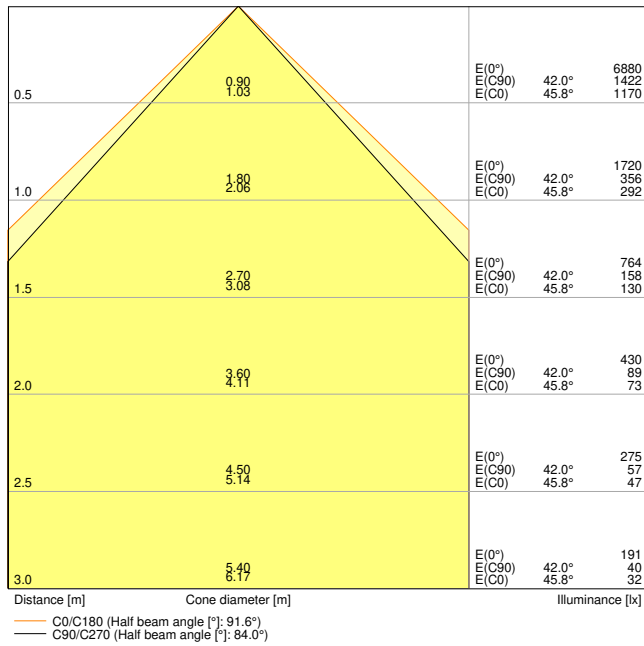

LDC typ cone

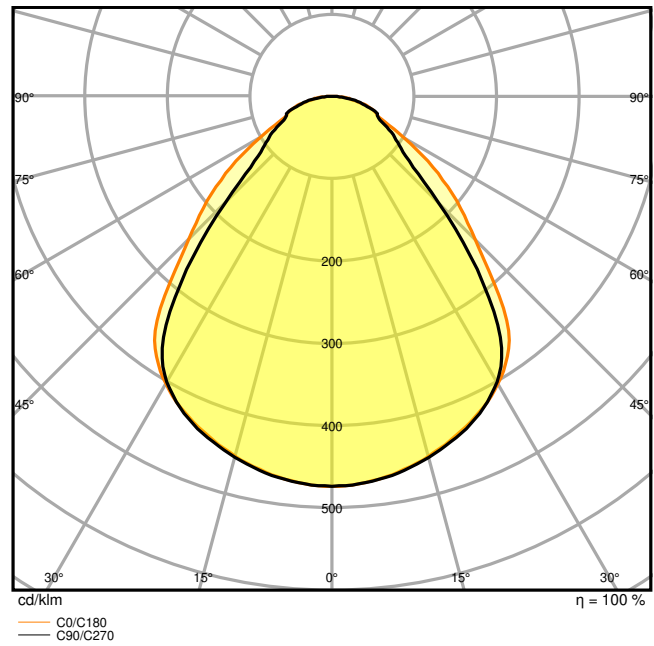

LDC typ polar

Dimensions & Weight

Length	595.00 mm
Width	595.00 mm
Height	32.00 mm
Product weight	1790.00 g

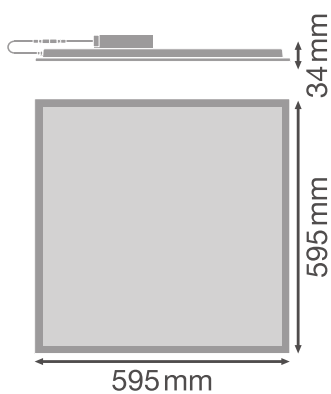

## Materials & Colors

Product color	White
Housing color	White
Body material	Aluminum
Cover material	Polystyrene (PS)
Light emitting surface material	Polystyrene
Glow Wire Test according to IEC 60695-2-12	650 °C
Mercury content	0.0 mg

## Application & Mounting

Ambient temperature range	-10...+45 °C
Temperature range at storage	-20...+70 °C
Type of connection	Screwless terminal, 2-Pole (L, N)
Type of protection	IP40/IP20
Protection class IK (shock resistance)	IK02
Dimmable	No
Mounting type	Recessed/Suspended/Surface
Mounting location	Ceiling
Application environment	Indoor
Mounting length	575 mm
Mounting width	575 mm
Mounting depth	50,0 mm
Adjustable	No
LED module replaceable	Not replaceable
With light source	Yes

## Lifespan

Lifespan L70/B50 at 25 °C	70000 h
Lifespan L80/B10 at 25 °C	50000 h
Lifespan L90/B10 at 25 °C	40000 h
Number of switching cycles	50000

## Control gear

Output current	700 mA
ECG - Output ripple current	< 7 %
ECG - Length	116.7 mm
ECG - Width	49.9 mm

ECG - Height	27 mm
Recommended control gear	LEDV DR DALI-P-44/220-240/1050

### Certificates & Standards

Standards	CE / CB / TÜV / UKCA / EAC
Luminaire with limited surface temperature, "D sign"	No
Ball shot safe	No









### Additional product data

Product remark	Available from December 2022
----------------	------------------------------

### EQUIPMENT / ACCESSORIES

- Accessories for several mounting options available
- Security rope for luminaire included
- Security brackets preinstalled
- External control gear included
- Suitable for use with separate Emergency Conversion Box
- Connector box with 5-pole terminal for through-wiring separately available for cable cross sections up to 2.5 mm<sup>2</sup>

### DOWNLOAD DATA

DOWNLOAD DATA	
	User instruction
	Addon Technical Information
	Tender documents
	Declarations Of Conformity CE
	IES file (IES)
	LDT file (Eulumdat)
	R3D file (Relux 3D Model)
	M3D file (3D Model)

## DOWNLOAD DATA



UGR file (UGR table)



Packaging insert

## LOGISTICAL DATA

Product code	Packaging unit (Pieces/Unit)	Dimensions (length x width x height)	Gross weight	Volume
4099854017063	Folding box 1	602 mm x 37 mm x 649 mm	2158.00 g	14.46 dm <sup>3</sup>
4099854017070	Shipping box 4	664 mm x 164 mm x 628 mm	9542.00 g	68.39 dm <sup>3</sup>

The mentioned product code describes the smallest quantity unit which can be ordered. One shipping unit can contain one or more single products. When placing an order, for the quantity please enter single or multiples of a shipping unit.

## ADDITIONAL CATALOG INFORMATION

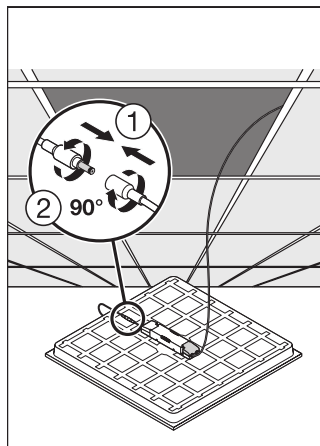
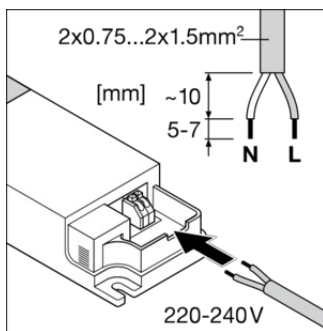

## References / Links

- Voor garantie zie [www.benelux.ledvance.com/garantie](http://www.benelux.ledvance.com/garantie)

## DISCLAIMER

Subject to change without notice. Errors and omission excepted. Always make sure to use the most recent release.