

PRODUCT DATASHEET

PL COMP 600 V 33W 830

PANEL COMPACT 600 | Square recessed panel luminaires, for 600 x 600 mm ceiling systems

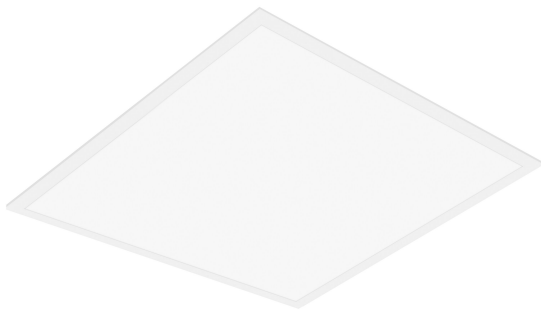

Areas of application

- Direct replacement for luminaires with fluorescent lamps
- Offices, conference rooms
- Reception areas, foyers, corridors, elevators
- Suitable for recessed ceiling systems with grid size of 600 x 600 mm

Product benefits

- Low flicker light thanks to special electronic control gear
- Energy savings thanks to system efficacy of up to 110 lm/W
- External driver for extended flexibility and easy installation
- Version with DALI ECG available
- 5 years guarantee

Product features

- Extruded aluminum frame
- Polystyrene diffuser
- Lifetime (L80/B10): up to 50,000 h (at 25 °C)



TECHNICAL DATA

Electrical data

| | |
|--|---------------------|
| Nominal wattage | 33.00 W |
| Nominal voltage | 220...240 V |
| Mains frequency | 50...60 Hz |
| Nominal current | 150.000 mA |
| Inrush current | 12.3 A |
| Inrush current time T_{h50} | 52 μ s |
| Max. no. of lum. on circuit break. B16 A | 61 |
| Max. no. of lum. on circuit break. C10 A | 61 |
| Max. no. of lum. on circuit break. C16 A | 78 |
| Power factor λ | > 0.90 |
| Total harmonic distortion | < 10 % |
| Protection class | II |
| Operating mode | External LED driver |

Photometrical data

| | |
|--|---------------------------|
| Luminous flux | 3630 lm |
| Luminous efficacy | 110 lm/W |
| Color temperature | 3000 K |
| Light color (designation) | Warm White |
| Color rendering index Ra | > 80 |
| Standard deviation of color matching | ≤ 5 sdc _m |
| Low flicker | Yes |
| Flickering metric (Pst LM) | <1 |
| Stroboscope effect metric (SVM) | < 0.4 |
| Photobiological safety group acc. to EN62778 | RG0 |
| Beam angle | 90 ° |



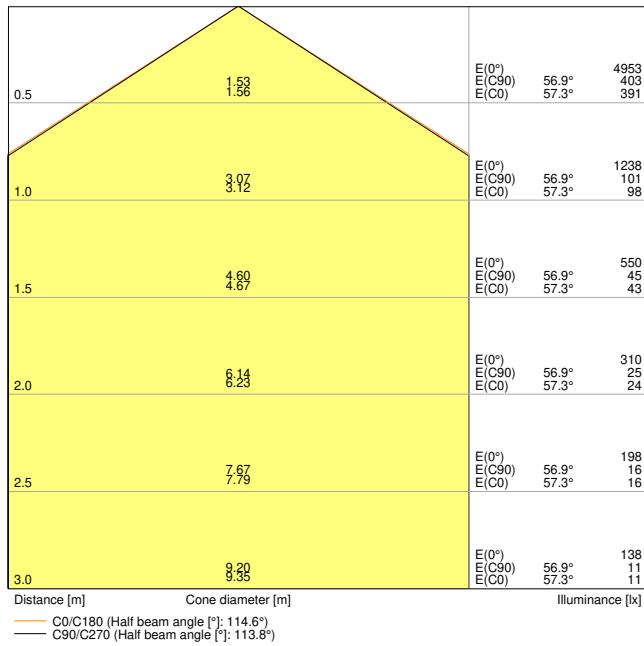

LDC typ cone

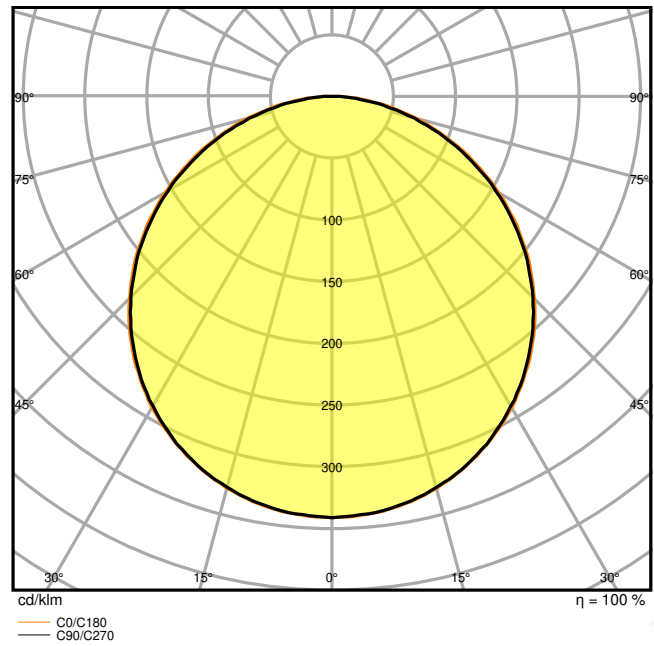

LDC typ polar

Dimensions & Weight

| | |
|----------------|-----------|
| Length | 595.00 mm |
| Width | 595.00 mm |
| Height | 32.00 mm |
| Product weight | 1543.00 g |

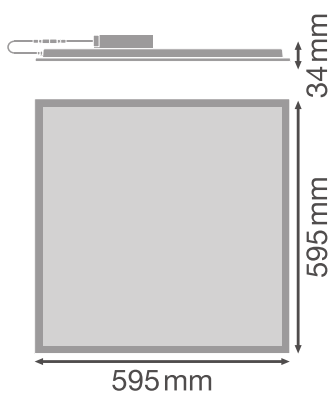

Materials & Colors

| | |
|--|------------------|
| Product color | White |
| Housing color | White |
| Body material | Aluminum |
| Cover material | Polystyrene (PS) |
| Light emitting surface material | Polystyrene |
| Glow Wire Test according to IEC 60695-2-12 | 650 °C |
| Mercury content | 0.0 mg |

Application & Mounting

| | |
|--|-----------------------------------|
| Ambient temperature range | -10...+45 °C |
| Temperature range at storage | -20...+70 °C |
| Type of connection | Screwless terminal, 2-Pole (L, N) |
| Type of protection | IP40/IP20 |
| Protection class IK (shock resistance) | IK02 |
| Dimmable | No |
| Mounting type | Recessed/Suspended/Surface |
| Mounting location | Ceiling |
| Application environment | Indoor |
| Mounting length | 575 mm |
| Mounting width | 575 mm |
| Mounting depth | 50,0 mm |
| Adjustable | No |
| LED module replaceable | Not replaceable |
| With light source | Yes |

Lifespan

| | |
|----------------------------|---------|
| Lifespan L70/B50 at 25 °C | 70000 h |
| Lifespan L80/B10 at 25 °C | 50000 h |
| Lifespan L90/B10 at 25 °C | 40000 h |
| Number of switching cycles | 50000 |

Control gear

| | |
|-----------------------------|----------|
| Output current | 700 mA |
| ECG - Output ripple current | < 7 % |
| ECG - Length | 116.7 mm |
| ECG - Width | 49.9 mm |

| | |
|--------------------------|--------------------------------|
| ECG - Height | 27 mm |
| Recommended control gear | LEDV DR DALI-P-44/220-240/1050 |

Certificates & Standards

| | |
|--|----------------------------|
| Standards | CE / CB / TÜV / UKCA / EAC |
| Luminaire with limited surface temperature, "D sign" | No |
| Ball shot safe | No |









Additional product data

| | |
|----------------|------------------------------|
| Product remark | Available from December 2022 |
|----------------|------------------------------|

EQUIPMENT / ACCESSORIES

- Accessories for several mounting options available
- Security rope for luminaire included
- Security brackets preinstalled
- External control gear included
- Suitable for use with separate Emergency Conversion Box
- Connector box with 5-pole terminal for through-wiring separately available for cable cross sections up to 2.5 mm²

DOWNLOAD DATA

| DOWNLOAD DATA | |
|--|-------------------------------|
|  | User instruction |
|  | Addon Technical Information |
|  | Tender documents |
|  | Declarations Of Conformity CE |
|  | IES file (IES) |
|  | LDT file (Eulumdat) |
|  | R3D file (Relux 3D Model) |
|  | M3D file (3D Model) |

DOWNLOAD DATA



UGR file (UGR table)



Packaging insert

LOGISTICAL DATA

| Product code | Packaging unit (Pieces/Unit) | Dimensions (length x width x height) | Gross weight | Volume |
|---------------|------------------------------|--------------------------------------|--------------|-----------------------|
| 4099854017742 | Folding box 1 | 602 mm x 37 mm x 649 mm | 1911.00 g | 14.46 dm ³ |
| 4099854017759 | Shipping box 4 | 664 mm x 164 mm x 628 mm | 8554.00 g | 68.39 dm ³ |

The mentioned product code describes the smallest quantity unit which can be ordered. One shipping unit can contain one or more single products. When placing an order, for the quantity please enter single or multiples of a shipping unit.

ADDITIONAL CATALOG INFORMATION

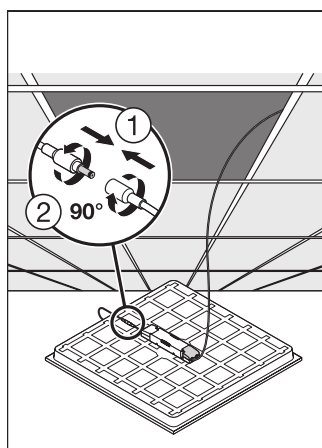
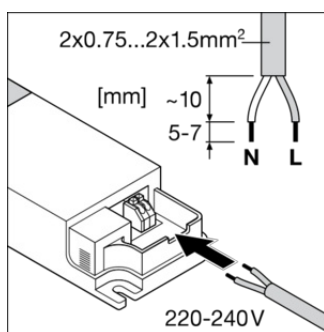

References / Links

- For Guarantee see www.ledvance.com/guarantee

DISCLAIMER

Subject to change without notice. Errors and omission excepted. Always make sure to use the most recent release.