

PCE data sheet

article#	0922-12v
article description	CEE-plug 32A 2p 42VAC 50/60Hz IP67 TWIST
description long	CEE-plug 32A 2p 42VAC 50/60Hz IP67 TWIST housing material: PA6 rated current: 32A number of poles: 2 (2P) clock-position: 12h rated voltage/frequency: 42V~ / 50+60Hz contacts: brass nickel plated connection technology: screw terminals IP protection class: IP67
GTIN (EAN)	9003399059742
country of origin	AT
customs number	85366990
net weight	0.157 kg
packaging quantity	10
minimum order quantity	10

ETIM 7.0	EC000140
IEC-amperage	32 A
Number of poles	2
Voltage acc. EN 60309-2	40-50 V (50+60 Hz) white
Clock hour position	12 h
Identification colour	White
Degree of protection (IP)	IP67
Connection system	Schraubklemme
Cable entry	Verschraubung
Angle of plug	Straight
Material	Plastic

a	135 mm
b	71 mm
K (cable Ø)	9,5-24 mm
SW	48 mm
wire flexible	1-10 mm ²
contact screws	160 Ncm
strain relief	600 Ncm
dismantling length	70 mm
stripping length	14-16 mm

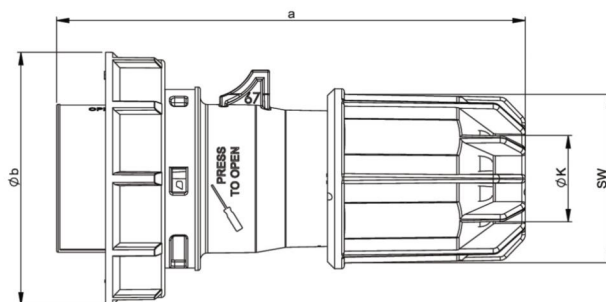

www.manufacturer-safety.info