

PCE data sheet

article#	034-4
article description	CEE-plug 63A 4p 4h IP67 POWER TWIST
description long	CEE-plug 63A 4p 4h IP67 POWER TWIST housing material: PA6 rated current: 63A number of poles: 4 (3P+PE) clock-position: 4h rated voltage/frequency: 100-130V~ / 50+60Hz contacts: brass nickel plated, with pilot pin connection technology: frame terminals with screws IP protection class: IP66/IP67
GTIN (EAN)	9003399040795
country of origin	AT
customs number	85366990
packaging quantity	2
minimum order quantity	2

ETIM 7.0	EC000140
IEC-amperage	63 A
Number of poles	4
Voltage acc. EN 60309-2	110 V (50+60 Hz) yellow
Clock hour position	4 h
Identification colour	Yellow
RAL-number	7046
Degree of protection (IP)	IP67
Connection system	Screwed terminal
Cable entry	Swivel
Angle of plug	Straight
Material	Plastic
Contact material	CuZn
Surface treatment contacts	Nickel-plated

a	250 mm
b	115 mm
K (cable Ø)	14,5-36 mm
SW	61 mm
wire flexible	6-16 mm ²
contact screws	200 Ncm
strain relief	1500 Ncm
dismantling length	100 mm
stripping length	15-18 mm

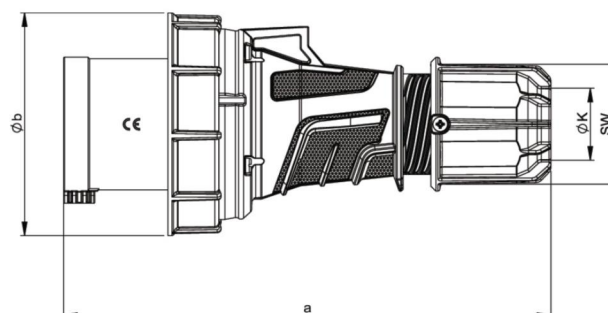

www.manufacturer-safety.info