

Surface Mounted	Panasonic Codes	Flush Mounted	Panasonic Codes	Accessories	Panasonic Codes
1 Gang	BQDT20101	2 Gang	BQDT1021	Insulated 6-Terminal	BQDT9106C
1&2 Gang	BQDT20201	4 Gang	BQDT1041	Insulated 10-Terminal	BQDT9110C
2 Gang	BQDT2021	6 Gang	BQDT1061		
3&4 Gang	BQDT20401	8 Gang	BQDT1081		
4 Gang	BQDT2041	12 Gang	BQDT1121		
6 Gang	BQDT2061	16 Gang	BQDT1161		
8 Gang	BQDT2081	18 Gang	BQDT1181		
12 Gang	BQDT2121	24 Gang	BQDT1241		
16 Gang	BQDT2161	36 Gang	BQDT1361		
18 Gang	BQDT2181				
24 Gang	BQDT2241				
36 Gang	BQDT2361				

Surface Mounted

1-Surface Mounted BQDT20101

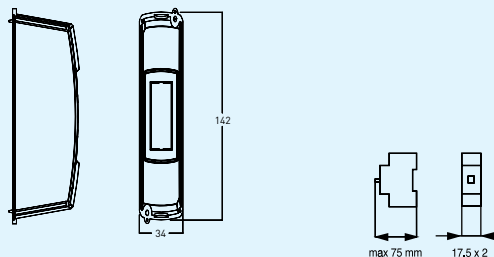

1-2 Surface Mounted BQDT20201

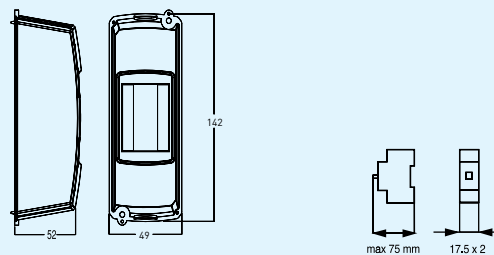

3-4 Surface Mounted BQDT20401

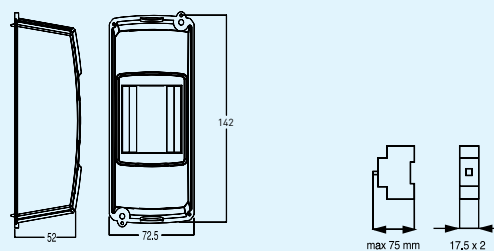

# Panasonic

## Flush Mounted

### 2 Flush Mounted BQDT1021

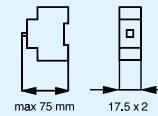
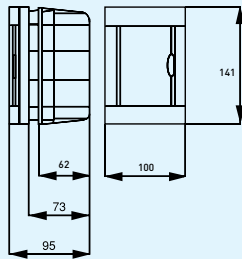

### 4 Flush Mounted BQDT1041

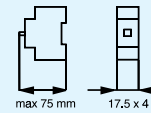
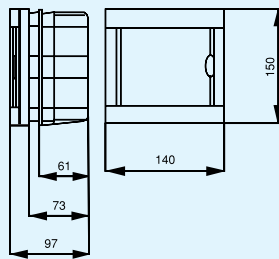

### 6 Flush Mounted BQDT1061

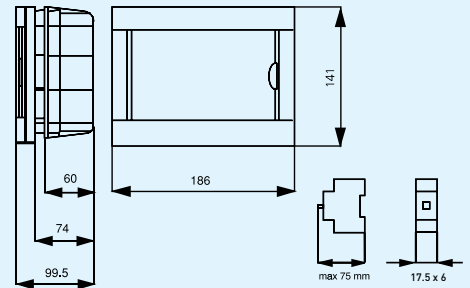

### 8 Flush Mounted BQDT1081



Locked cover system

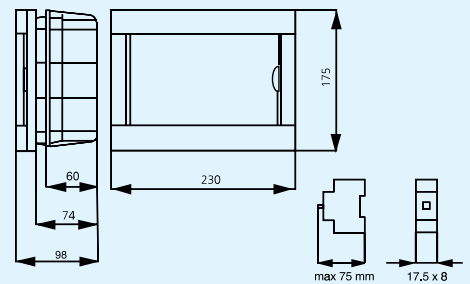
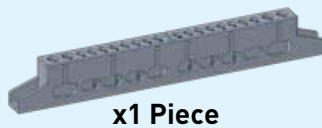

### 12 Flush Mounted BQDT1121



Locked cover system

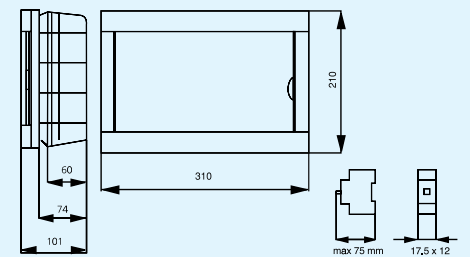
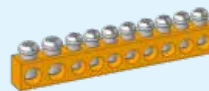
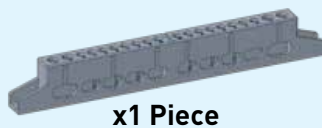

**16 Flush Mounted BQDT1161**



Locked cover system



**x1 Piece**



**x2 Piece**

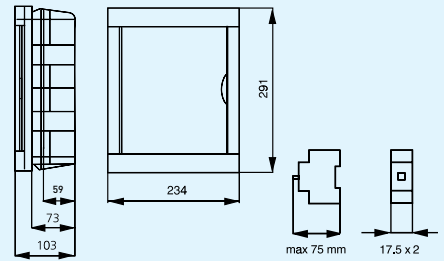

**18 Flush Mounted BQDT1181**



Locked cover system



**x1 Piece**



**x2 Piece**

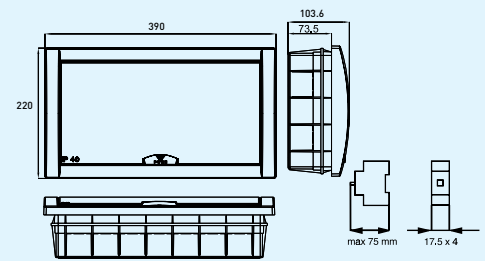

**24 Flush Mounted BQDT1241**



Locked cover system



**x2 Piece**



**x4 Piece**

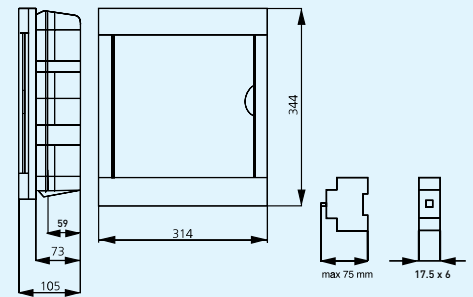

**36 Flush Mounted BQDT1361**



Locked cover system



**x2 Piece**

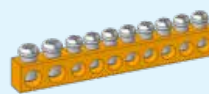

**x4 Piece**

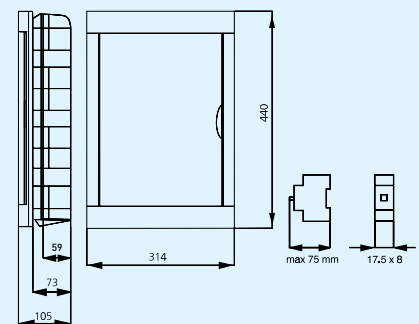

# Panasonic

## Surface Mounted

### 2 Surface Mounted BQDT2021

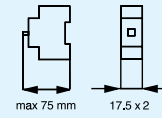
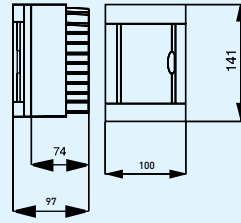

### 4 Surface Mounted BQDT2041

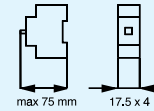
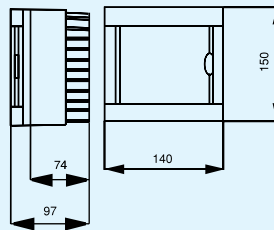

### 6 Surface Mounted BQDT2061

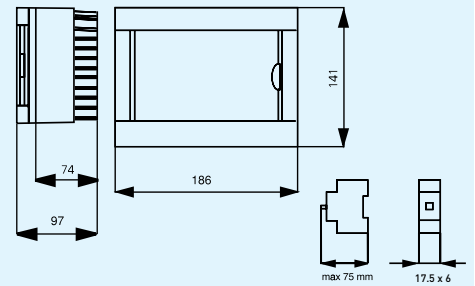
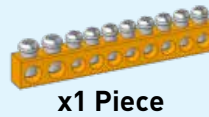

### 8 Surface Mounted BQDT2081

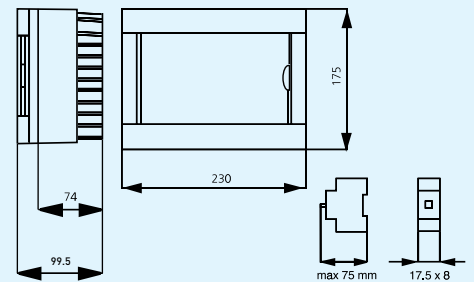
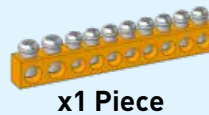

### 12 Surface Mounted BQDT2121

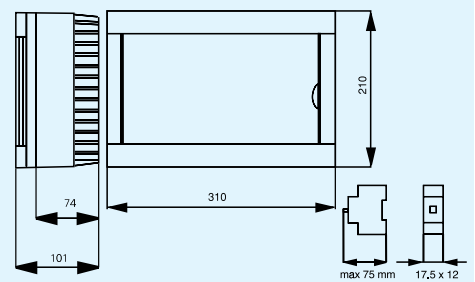
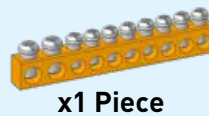

**16 Surface Mounted BQDT2161**



Locked cover system



**x1 Piece**



**x2 Piece**

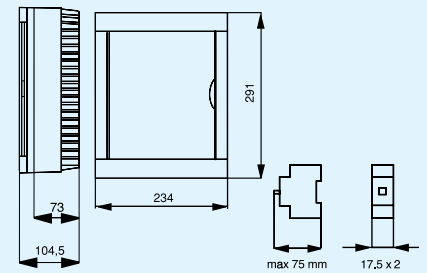

**18 Surface Mounted BQDT2181**



Locked cover system



**x1 Piece**



**x2 Piece**

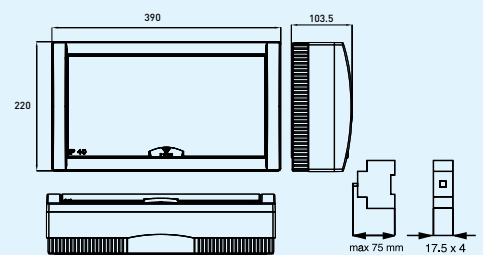

**24 Surface Mounted BQDT2241**



Locked cover system



**x2 Piece**



**x4 Piece**

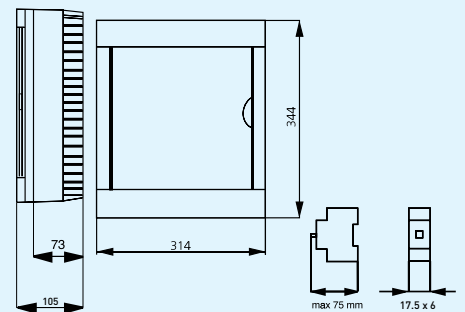

**36 Surface Mounted BQDT2361**



Locked cover system



**x2 Piece**

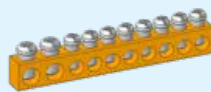

**x4 Piece**

